



CATÁLOGO DE PRODUTOS



AGUIA

METAIS



# ÍNDICE

Linha Quadrat - 05	Linha Filtros - 69
Linha Quadrat Flat - 11	Linha Lavatório - 71
Linha Monocomando - 18	Linha Cozinha - 73
Versatti - 23	Linha Tanque e Jardim - 74
Linha Essence - 25	Linha Le Premium - 76
Linha Stillus - 27	Linha Le - 77
Linha Stillus Prática - 37	Linha ABS - 80
Linha Stillus Fit - 41	Registros de Pressão - 81
Linha Clínica - 43	Registros de Pressão/Registros LE - 82
Linha Elegance - 44	Registros de Gaveta / Acab. p/ Reg. LE - 83
Linha Color Shower - 48	Acabamentos p/ Registros - 84
Linha Color Flex - 50	Volantes/ Cruzetas e Alavancas - 86
Linha Gourmet Shower - 52	Duchas / Gatilhos - 87
Linha Gourmet - 54	Acessórios p/ Banheiro - 88
Linha Color Shower Fit - 56	Porta Shampoo - 95
Linha Color Flex Fit - 57	Acessórios p/ Banheiros e Cozinha - 96
Linha Gourmet Shower Fit - 58	Alças de Apoio - 97
Linha Gourmet Fit - 59	Ralos e Grelhas / Conexões - 98
Linha Premium - 60	Válvulas - 99
Linha Flat - 62	Puxadores / Régua Gabarito / Salva Registro - 101
Linha Classic - 63	Mecanismos de Vedação - 102
Linha Automatic - 68	Diversos - 103
	Expositores - 106



# LINHA QUADRAT



7007  
Torneira Baixa Quadrat de Mesa  
p/ Lavatório c/ Arejador

**CÓDIGO**

23471



7007  
Torneira Quadrat de Mesa  
p/ Cozinha ou Lavatório c/ Arej. 75°

**CÓDIGO**

18723



7007  
Torneira Quadrat de Mesa  
p/ Cozinha ou Lavatório c/ Arej. 90°

**CÓDIGO**

23470

# LINHA QUADRAT BLACK



7007  
Torneira Quadrat de Mesa  
Cozinha/Lavatório Black 1/4 de Volta

**CÓDIGO**

27383



7007  
Torneira Quadrat de Mesa  
Cozinha/Lavatório 75° Black 1/4 de Volta

**CÓDIGO**

27384



7007  
Torneira Quadrat de Mesa  
Cozinha/Lavatório 90° Black 1/4 de Volta

**CÓDIGO**

27385



MECANISMO 1/4 DE VOLTA M18



AREJADOR ECONOMIZADOR DE ÁGUA

# LINHA QUADRAT GOLD



7007  
Torneira Quadrat de Mesa  
Cozinha/Lavatório Gold 1/4 de Volta

CÓDIGO

28394



7007  
Torneira Quadrat de Mesa  
Cozinha/Lavatório 75° Gold 1/4 de Volta

CÓDIGO

28396



7007  
Torneira Quadrat de Mesa  
Cozinha/Lavatório 90° Gold 1/4 de Volta

CÓDIGO

28398

# LINHA QUADRAT ROSE

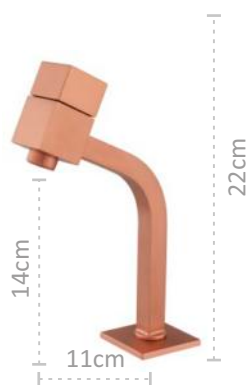

7007  
Torneira Baixa Quadrat de Mesa  
p/ Lavatório c/ Arejador Rose 1/4 de Volta

CÓDIGO

28395



7007  
Torneira Quadrat de Mesa p/ Cozinha  
ou Lavatório c/ Arej. 75° Rose 1/4 de Volta

CÓDIGO

28397

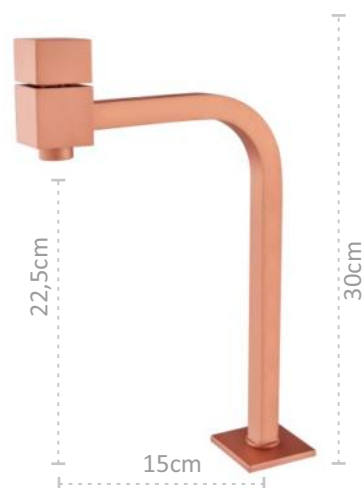

7007  
Torneira Quadrat de Mesa p/ Cozinha  
ou Lavatório c/ Arej. 90° Rose 1/4 de Volta

CÓDIGO

28399



LINHA

# QUADRAT

MISTURADORES  
E TORNEIRAS



7002  
Torneira Quadrat de  
Mesa p/ Lavatório c/  
Arej. Articulado

CÓDIGO

6993



7003  
Torneira Quadrat de  
Mesa p/ Cozinha c/  
Arej. Articulado

CÓDIGO

6994



7004  
Torneira Quadrat de  
Parede c/ Arej. Articulado

CÓDIGO

6996



7000  
Misturador Quadrat de Mesa p/ Lavatório c/  
Arej. Articulado

CÓDIGO

6990



7000  
Misturador Quadrat de Mesa p/ Cozinha c/  
Arej. Articulado

CÓDIGO

6991



1739  
Ducha Articulada Quadrato  
Cromada

**CÓDIGO**  
564



1739  
Ducha Articulada Quadrato  
Black

**CÓDIGO**  
27141



1739  
Ducha Articulada Quadrato  
Gold

**CÓDIGO**  
27142

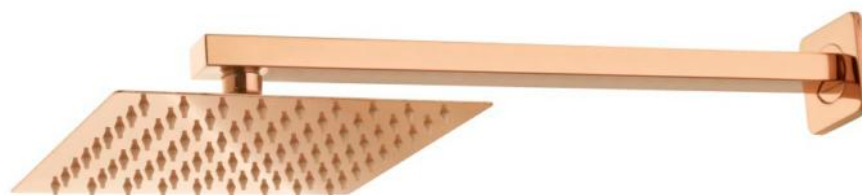

1739  
Ducha Articulada Quadrato  
Rose

**CÓDIGO**  
27143

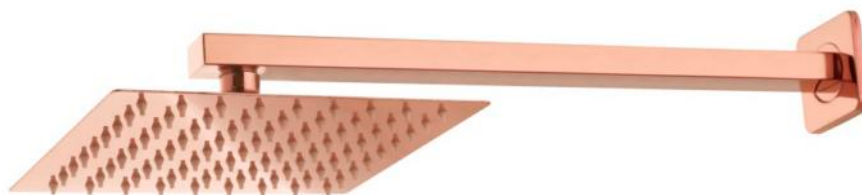

LINHA  
**QUADRAT** ACESSÓRIOS  
PARA BANHEIRO



7006  
Ducha Higiênica  
Quadrat

**CÓDIGO**

16945



7006  
Ducha Higiênica  
Quadrat Black

**CÓDIGO**

27144



7006  
Ducha Higiênica  
Quadrat Gold

**CÓDIGO**

27145



7006  
Ducha Higiênica  
Quadrat Rose

**CÓDIGO**

27146

LINHA  
**QUADRAT** ACESSÓRIOS  
PARA BANHEIRO



6600  
Acessórios para Banheiro  
05 Peças Quadrát Black (Latão) **CÓDIGO**  
26204



Porta Toalha de Rosto  
Quadrát Black



Saboneteira  
Quadrát Black



Papeleira  
Quadrát Black



Cabide  
Quadrát Black



Porta Toalha de Banho  
Quadrát Black



6620  
Porta Shampoo Quadrát

**CÓDIGO**  
264



6560  
Porta Toalha de Banho Quadrát

**CÓDIGO**  
265



6560  
Porta Toalha de Rosto Quadrát

**CÓDIGO**  
266



6530  
Saboneteira Quadrát

**CÓDIGO**  
276



6540  
Papeleira Quadrát

**CÓDIGO**  
2557



6580  
Cabide Quadrát

**CÓDIGO**  
267

LINHA

# QUADRAT FLAT

TORNEIRAS

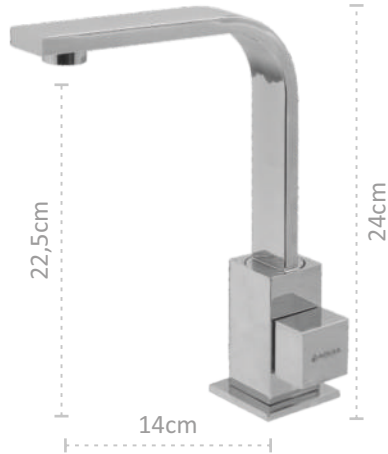

7010  
Torneira Quadrat Flat  
de Mesa p/ Cozinha ou  
Lavatório Baixa

**CÓDIGO**  
26093

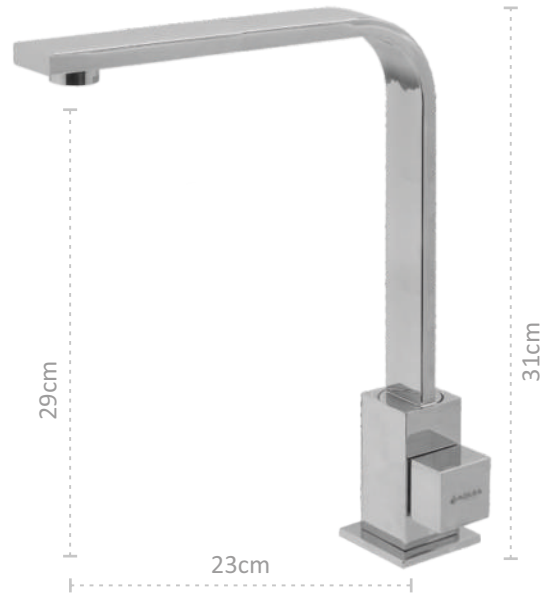

7010  
Torneira Quadrat Flat  
de Mesa p/ Cozinha ou  
Lavatório Alta

**CÓDIGO**  
26095

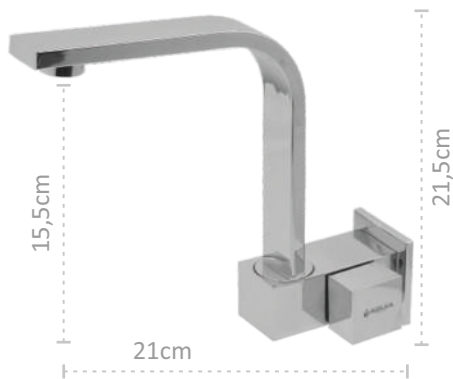

7010  
Torneira Quadrat Flat  
de Parede p/ Cozinha Baixa

**CÓDIGO**  
26096

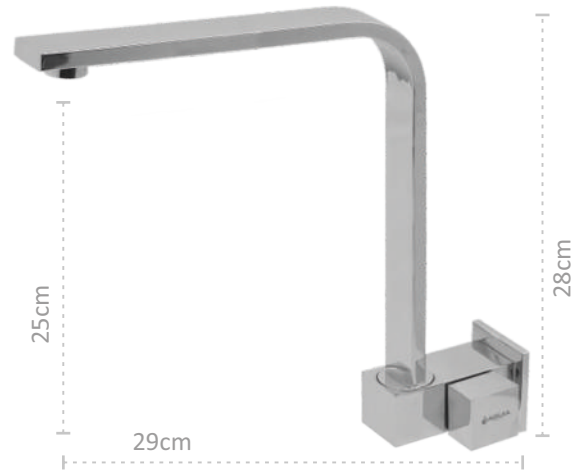

7010  
Torneira Quadrat Flat  
de Parede p/ Cozinha Alta

**CÓDIGO**  
26097



LINHA

# QUADRAT FLAT BLACK



7010  
Torneira Quadrat Flat Black  
de Mesa p/ Cozinha ou  
Lavatório Baixa

**CÓDIGO**  
27377



7010  
Torneira Quadrat Flat Black  
de Mesa p/ Cozinha ou  
Lavatório Alta

**CÓDIGO**  
27387



7010  
Torneira Quadrat Flat Black  
de Parede p/ Cozinha Baixa

**CÓDIGO**  
27389



7010  
Torneira Quadrat Flat Black  
de Parede p/ Cozinha Alta

**CÓDIGO**  
27379



LINHA

# QUADRAT FLAT GOLD



7010  
Torneira Quadrat Flat Gold  
de Mesa p/ Cozinha ou  
Lavatório Baixa

**CÓDIGO**  
28388



7010  
Torneira Quadrat Flat Gold  
de Mesa p/ Cozinha ou  
Lavatório Alta

**CÓDIGO**  
28386



7010  
Torneira Quadrat Flat Gold  
de Parede p/ Cozinha Baixa

**CÓDIGO**  
28392



7010  
Torneira Quadrat Flat Gold  
de Parede p/ Cozinha Alta

**CÓDIGO**  
28390



LINHA

# QUADRAT FLAT ROSE



7010  
Torneira Quadrat Flat Rose  
de Mesa p/ Cozinha ou  
Lavatório Baixa

**CÓDIGO**  
28389



7010  
Torneira Quadrat Flat Rose  
de Mesa p/ Cozinha ou  
Lavatório Alta

**CÓDIGO**  
28387



7010  
Torneira Quadrat Flat Rose  
de Parede p/ Cozinha Baixa

**CÓDIGO**  
28393



7010  
Torneira Quadrat Flat Rose  
de Parede p/ Cozinha Alta

**CÓDIGO**  
28391



LINHA

# QUADRAT FLAT

ACESSÓRIOS



Padrão de Instalação:



6600  
Acessórios para Banheiro 5 Peças  
Quadrat Flat Cromado

CÓDIGO

27792

Porta Toalha Banho  
Quadrat Flat Cromado

CÓDIGO

28805



Saboneteira  
Quadrat Flat Cromado

CÓDIGO

28803



Cabide  
Quadrat Flat  
Cromado

CÓDIGO

28807



Papeleira  
Quadrat Flat  
Cromado

CÓDIGO

28804



Porta Toalha Rosto  
Quadrat Flat Cromado

CÓDIGO

28806



Padrão de Instalação:

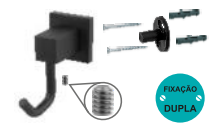

6600  
Acessórios para Banheiro 5 Peças  
Quadrat Flat Black

CÓDIGO

27734

Porta Toalha Banho  
Quadrat Flat Black

CÓDIGO

28770



Saboneteira  
Quadrat Flat Black

CÓDIGO

28766



Cabide  
Quadrat Flat  
Black

CÓDIGO

28769



Papeleira  
Quadrat Flat  
Black

CÓDIGO

28767

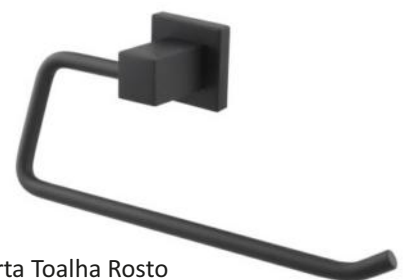

Porta Toalha Rosto  
Quadrat Flat Black

CÓDIGO

28768

LINHA

# QUADRAT FLAT

ACESSÓRIOS



6600  
Acessórios para Banheiro 5 Peças  
Quadrat Flat Gold Matte

CÓDIGO

28422



Porta Toalha Banho  
Quadrat Flat Gold

CÓDIGO

28777

Padrão de Instalação:

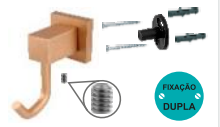

FIXAÇÃO  
DUPLA



Saboneteira  
Quadrat Flat Gold

CÓDIGO

28772



Cabide Quadrat  
Flat Gold

CÓDIGO

28781



Papeleira  
Quadrat Flat Gold

CÓDIGO

28774

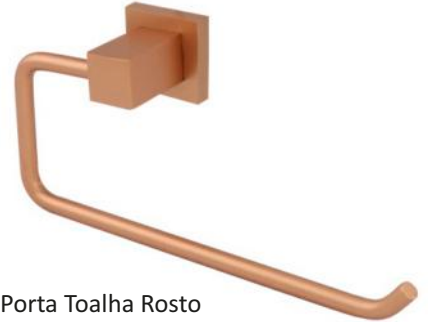

Porta Toalha Rosto  
Quadrat Flat Gold

CÓDIGO

28779



6600  
Acessórios para Banheiro 5 Peças  
Quadrat Flat Rose Matte

CÓDIGO

28411

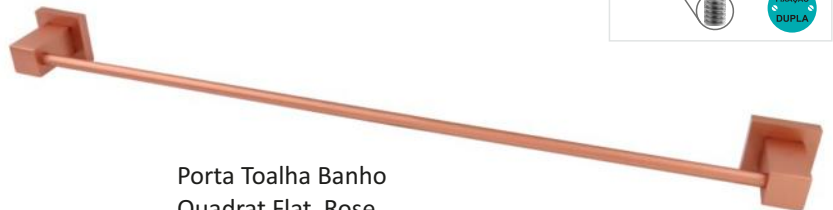

Porta Toalha Banho  
Quadrat Flat Rose

CÓDIGO

28778

Padrão de Instalação:

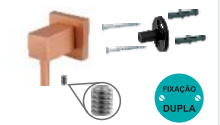

FIXAÇÃO  
DUPLA



Saboneteira  
Quadrat Flat Rose

CÓDIGO

28773



Cabide Quadrat  
Flat Rose

CÓDIGO

28782



Papeleira  
Quadrat Flat Rose

CÓDIGO

28775

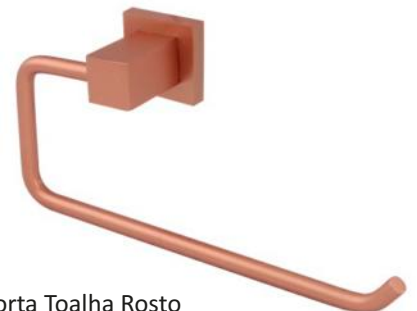

Porta Toalha Rosto  
Quadrat Flat Rose

CÓDIGO

28780



1878  
Misturador Monocomando  
Mesa Gourmet Black/Bronze  
c/ 2 Bicas

**CÓDIGO**  
25747

1878  
Misturador  
Monocomando  
Chrome Alto  
Lavatório

**CÓDIGO**  
26194



1878  
Misturador  
Monocomando  
Chome Baixo  
Lavatório

**CÓDIGO**  
26190



1878  
Misturador  
Monocomando  
Gold Alto  
Lavatório

**CÓDIGO**  
26197



1878  
Misturador  
Monocomando  
Gold Baixo  
Lavatório

**CÓDIGO**  
26193



1878  
Misturador  
Monocomando  
Bronze Alto  
Lavatório

**CÓDIGO**  
26195



1878  
Misturador  
Monocomando  
Bronze Baixo  
Lavatório

**CÓDIGO**  
26191



1878  
Misturador  
Monocomando  
Black Alto  
Lavatório

**CÓDIGO**  
26196



1878  
Misturador  
Monocomando  
Black Baixo  
Lavatório

**CÓDIGO**  
26192



# MISTURADORES MONOCOMANDOS



1878 - Azul  
Misturador  
Monocomando  
Mesa Gourmet  
Color Flex

CÓDIGO  
26200

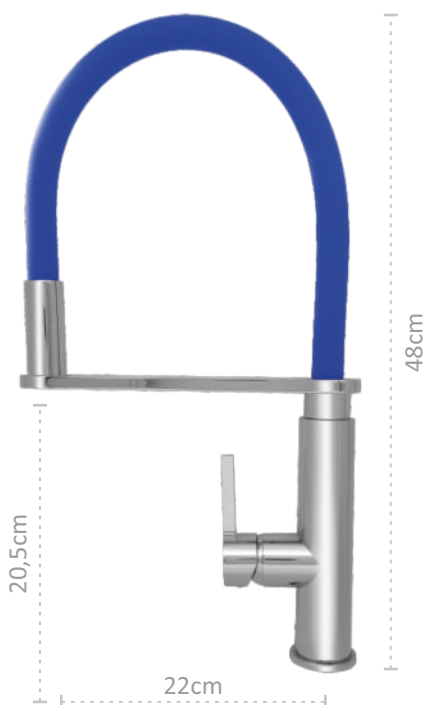

1878 - Branco  
Misturador  
Monocomando  
Mesa Gourmet  
Color Flex

CÓDIGO  
26199

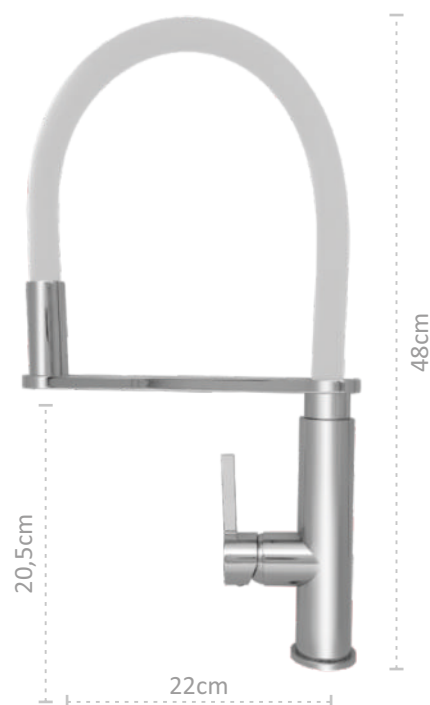

1878 - Preto  
Misturador  
Monocomando  
Mesa Gourmet  
Color Flex

CÓDIGO  
26201

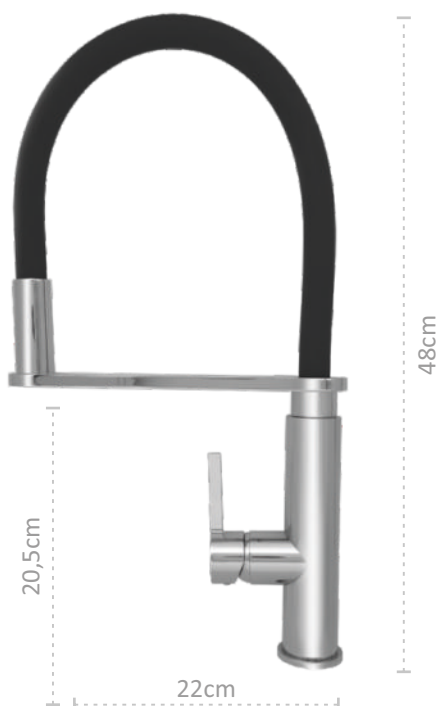

1878 - Vermelho  
Misturador  
Monocomando  
Mesa Gourmet  
Color Flex

CÓDIGO  
26198

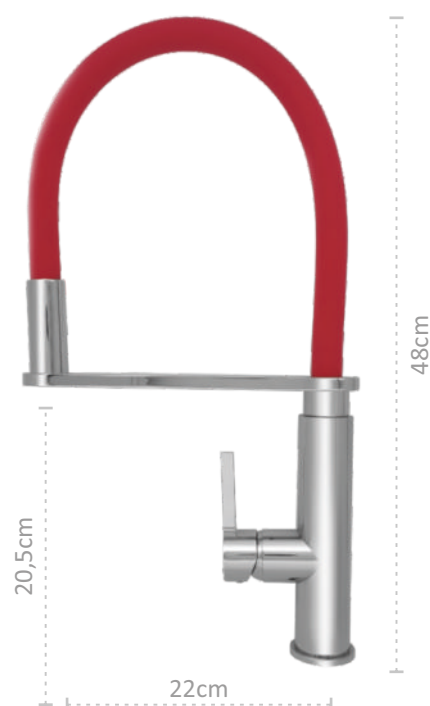



# MISTURADORES MONOCOMANDOS



1878  
Misturador  
Monocomando  
de Mesa p/ Cozinha  
Gourmet Luxo com  
Ducha Flexível

CÓDIGO

25746

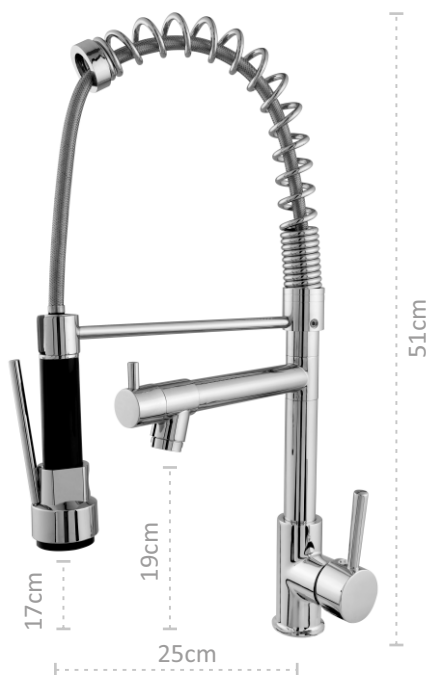

1878  
Misturador  
Monocomando  
de Mesa p/ Cozinha  
Gourmet Luxo com  
Ducha Flexível

CÓDIGO

17214



1878  
Misturador  
Monocomando  
de Mesa  
Altus

CÓDIGO

18764



1878  
Misturador  
Monocomando  
Mesa Prime

CÓDIGO

18768



# MISTURADORES MONOCOMANDOS



1878  
Misturador  
Monocomando  
Cascata p/ Lavatório

CÓDIGO

1448



1878  
Misturador  
Monocomando  
Cascata p/ Lavatório Alta

CÓDIGO

10847



1878  
Misturador Monocomando  
de Mesa p/ Cozinha  
Giratório Baixa

CÓDIGO

562



1878  
Misturador  
Monocomando  
p/ Lavatório

CÓDIGO

561



1878  
Misturador Monocomando  
de Mesa p/ Cozinha  
Giratório Alta

CÓDIGO

563



1878  
Misturador Monocomando  
de Mesa p/ Cozinha  
c/ Ducha Extensível

CÓDIGO

610



1878  
Misturador  
Monocomando  
p/ Chuveiro

CÓDIGO

611





4001  
Torneira Versatti  
Color Flex Mesa

	AZUL	BRANCO	PRETO	VERM.
C26	24129	24132	24181	24136
C27	24131	24135	24184	24139
C55	23429	23434	23442	23438
C69	24122	24133	24182	24137
C70	23431	23436	23444	23440
C75	23432	23437	23445	23441
C79	24130	24134	24183	24138
C90	23430	23435	23443	23439



4001  
Torneira Versatti  
Color Flex Parede

	AZUL	BRANCO	PRETO	VERM.
C26	24140	24144	24148	24152
C27	24143	24147	24151	24155
C55	23393	23400	23408	23404
C69	24141	24145	24149	24153
C70	23396	23402	23410	23406
C75	23397	23403	23411	23407
C79	24142	24146	24150	24154
C90	23394	23401	23409	23405



4002  
Torneira Versatti  
Color Shower Mesa

	AZUL	PRETO	VERM.
C26	24156	24160	24164
C27	24159	24163	24167
C55	23447	23456	23452
C69	24157	24161	24165
C70	23450	23459	23454
C75	23451	23460	23455
C79	24158	24162	24166
C90	23449	23458	23453



4002  
Torneira Versatti  
Color Shower Parede

	AZUL	PRETO	VERM.
C26	24168	24172	24176
C27	24171	24175	24180
C55	23412	23420	23416
C69	24169	24173	24177
C70	23414	23423	23418
C75	23415	23424	23419
C79	24170	24174	24179
C90	23413	23421	23417



Corpo Quadrado  
Robusto



# LINHA VERSATTI



MESA	
C26	24120
C27	24125
C55	23425
C69	24123
C70	23427
C75	23428
C79	24124
C90	23426

**4000**  
Torneira Versatti  
Gourmet Mesa

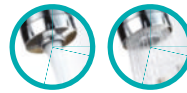

PAREDE	
C26	24121
C27	24128
C55	23387
C69	24126
C70	23391
C75	23392
C79	24127
C90	23390

**4000**  
Torneira Versatti  
Gourmet Parede

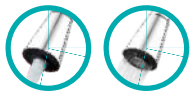

MESA	
C26	24405
C27	24406
C55	24407
C69	24408
C70	24410
C75	24411
C79	24412
C90	24413

**4003**  
Torneira Versatti  
Gourmet Shower  
Cromada Mesa

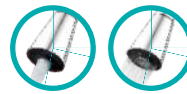

PAREDE	
C26	24414
C27	24415
C55	24416
C69	24417
C70	24418
C75	24419
C79	24421
C90	24422

**4003**  
Torneira Versatti  
Gourmet Shower  
Cromada Parede



Corpo Quadrado  
Robusto



# LINHA ESSENCE



6003  
Torneira Essence  
Flat Cozinha  
Bica Móvel c/ Arej.  
Articulado Mesa

**CÓDIGO**

24107



6003  
Torneira Essence  
p/ Cozinha Giratória  
c/ Arej. Articulado Mesa

**CÓDIGO**

13305



6002  
Torneira Essence  
Flat Parede Cozinha  
Bica Móvel c/ Arej.  
Articulado

**CÓDIGO**

24105



6002  
Torneira Essence  
Parede Cozinha Bica  
Móvel c/ Arej.  
Articulado

**CÓDIGO**

13319



6004  
Torneira Essence  
Flat Mesa Lavatório  
Bica Móvel

**CÓDIGO**

24108



6004  
Torneira Essence  
Mesa Lavatório  
Bica Móvel

**CÓDIGO**

13306



# LINHA ESSENCE



6001  
Misturador Essence de Mesa  
p/ Lavatório

**CÓDIGO**  
13303



6000  
Misturador Essence  
de Mesa ou Parede  
p/ Cozinha Giratória  
c/ Arej. Articulado

**CÓDIGO**  
13302



1739  
Ducha Articulada Essence

**CÓDIGO**  
13437



6005  
Ducha Higiênica Essence

**CÓDIGO**  
13308

6006  
Acabamento para  
Registro Essence  
1/2", 3/4" e 1"

**CÓDIGO**  
13307



# LINHA STILLUS



LINHA

STILLUS



AGUIA  
METAIS



1171  
Torneira Stillus de  
Parede Reta

CÓDIGO

986

18cm



1171  
Torneira Stillus de  
Parede 25°

CÓDIGO

11331

19cm



1171  
Torneira Stillus Baixa  
de Mesa

CÓDIGO

1102

13cm

11cm

20cm



1171  
Torneira Stillus Alta  
de Mesa 75°

CÓDIGO

1083

28cm

17cm

36cm



1171  
Torneira Stillus Alta  
de Mesa 90°

CÓDIGO

1101

29cm

18,5cm

36cm



LINHA

# STILLUS BLACK MATTE



1171  
Torneira Stillus Black Matte de  
Parede Reta 1/4 de Volta

18cm

CÓDIGO

28554



1171  
Torneira Stillus Black Matte de  
Parede 25° 1/4 de Volta

19cm

CÓDIGO

28553



1171  
Torneira Stillus Black Matte Baixa  
de Mesa 1/4 de Volta

13cm

11cm

20cm

CÓDIGO

25331



1171  
Torneira Stillus Black Matte Alta  
de Mesa 75° 1/4 de Volta

28cm

17cm

36cm

CÓDIGO

25332



1171  
Torneira Stillus Black Matte Alta  
de Mesa 90° 1/4 de Volta

29cm

18,5cm

36cm

CÓDIGO

25333



LINHA

# STILLUS GOLD MATTE



1171  
Torneira Stillus Gold Matte de  
Parede Reta 1/4 de Volta

CÓDIGO

28601

18cm



1171  
Torneira Stillus Gold Matte de  
Parede 25° 1/4 de Volta

CÓDIGO

28465

19cm



1171  
Torneira Stillus Gold Matte Baixa  
de Mesa 1/4 de Volta

CÓDIGO

25328

13cm

11cm

20cm



1171  
Torneira Stillus Gold Matte Alta  
de Mesa 75° 1/4 de Volta

CÓDIGO

25329

28cm

17cm

36cm



1171  
Torneira Stillus Gold Matte Alta  
de Mesa 90° 1/4 de Volta

CÓDIGO

25330

29cm

18,5cm

36cm



LINHA

# STILLUS ROSE MATTE



1171  
Torneira Stillus Rose Matte de  
Parede Reta 1/4 de Volta

18cm

CÓDIGO

28602



1171  
Torneira Stillus Rose Matte de  
Parede 25° 1/4 de Volta

19cm

CÓDIGO

28466



1171  
Torneira Stillus Rose Matte Baixa  
de Mesa 1/4 de Volta

13cm

11cm

20cm

CÓDIGO

25324



1171  
Torneira Stillus Rose Matte Alta  
de Mesa 75° 1/4 de Volta

28cm

17cm

36cm

CÓDIGO

25326



1171  
Torneira Stillus Rose Matte Alta  
de Mesa 90° 1/4 de Volta

29cm

18,5cm

36cm

CÓDIGO

25327



LINHA

# STILLUS



**AGUIA**  
METAIS



1876  
Misturador Stillus  
de Parede

**CÓDIGO**

3044



1875  
Misturador Stillus  
de Mesa

**CÓDIGO**

3043



1739  
Ducha Articulada  
Stillus Master

**CÓDIGO**

3082



1739  
Ducha Articulada  
Stillus 3 Funções

**CÓDIGO**

3081

1554  
Acabamento Stillus  
1/2", 3/4" e 1"

**CÓDIGO**

3041



LINHA

**STILLUS**



**AGUIA**  
METAIS



1839  
Misturador Stillus  
Ducha Higiênica

**CÓDIGO**

3045



1739  
Stillus Ducha  
Higiênica

**CÓDIGO**

3042



1739  
Ducha Higiênica Stillus Black

**CÓDIGO**

28117



1739  
Ducha Higiênica Stillus Gold

**CÓDIGO**

28123



1739  
Ducha Higiênica Stillus Rose

**CÓDIGO**

28119



# LINHA STILLUS

## ACESSÓRIOS PARA BANHEIRO



6600  
Acessórios p/ Banheiro  
05 Peças Stillus

**CÓDIGO**  
3426

Padrão de Instalação:



FIXAÇÃO  
DUPLA

6560  
Porta Toalha de  
Rosto Stillus

**CÓDIGO**  
3047



6530  
Saboneteira Stillus

**CÓDIGO**  
3049



6540  
Papeleira Stillus

**CÓDIGO**  
3048



6580  
Cabide Stillus

**CÓDIGO**  
3046



6560-Banho  
Porta Toalha de Banho Stillus

**CÓDIGO**  
3050



6620  
Porta Shampoo Stillus

**CÓDIGO**  
3051



6540  
Papeleira Dupla Stillus

**CÓDIGO**  
16980



6600  
Acessórios para Banheiro  
05 peças Stillus Black

**CÓDIGO**  
27498

Padrão de Instalação:



FIXAÇÃO  
DUPLA

6560 - Porta  
Toalha Rosto  
Stillus Black

**CÓDIGO**  
27485



6530 - Saboneteira  
Stillus Black

**CÓDIGO**  
27496



6540 - Papeleira  
Stillus Black

**CÓDIGO**  
27486



6580 - Cabide  
Stillus Black

**CÓDIGO**  
27482



6560 - Porta Toalha  
Banho Stillus Black

**CÓDIGO**  
27483



6620 - Porta Shampoo  
Stillus Black

**CÓDIGO**  
27497



LINHA  
**STILLUS** ACESSÓRIOS  
PARA BANHEIRO



6600  
Acessórios p/ Banheiro  
05 Peças Stillus Gold

**CÓDIGO**  
28357

Padrão de Instalação:



6560  
Porta Toalha de  
Rosto Stillus Gold

**CÓDIGO**  
28736



6530  
Saboneteira Stillus Gold

**CÓDIGO**  
28730



6540  
Papeleira Stillus Gold

**CÓDIGO**  
28732



6580  
Cabide Stillus Gold

**CÓDIGO**  
28738



6560  
Porta Toalha de Banho Stillus Gold

**CÓDIGO**  
28734



6600  
Acessórios para Banheiro  
05 peças Stillus Rose

**CÓDIGO**  
28359

Padrão de Instalação:

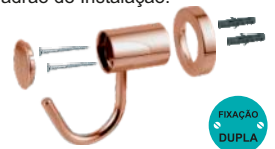

6560 - Porta  
Toalha Rosto  
Stillus Rose

**CÓDIGO**  
28737



6530 - Saboneteira  
Stillus Rose

**CÓDIGO**  
28731



6540 - Papeleira  
Stillus Rose

**CÓDIGO**  
28733



6580 - Cabide  
Stillus Rose

**CÓDIGO**  
28739



6560 - Porta Toalha  
Banho Stillus Rose

**CÓDIGO**  
28735





LINHA

# STILLUS PRÁTICA



**AGUIA**  
METAIS



18cm

1171  
Torneira Stillus Prática de  
Parede Reta

**SACOLA** **BLISTER**  
15879 14824



19cm

1171  
Torneira Stillus Prática de  
Parede 25°

**SACOLA** **BLISTER**  
15877 14825



13cm

11cm

20cm

1171  
Torneira Stillus Prática Baixa  
de Mesa

**SACOLA** **BLISTER**  
15876 14190



28cm

17cm

31cm

1171  
Torneira Stillus Prática Alta  
de Mesa 75°

**SACOLA** **BLISTER**  
15875 14191



29cm

18,5cm

32cm

1171  
Torneira Stillus Prática Alta  
de Mesa 90°

**SACOLA** **BLISTER**  
15878 14192



LINHA

# STILLUS PRÁTICA BLACK

AGUIA  
METAIS



18cm

1171  
Torneira Stillus Prática de  
Parede Reta Black 1/4 de Volta - DN 15

CÓDIGO

28160



19cm

1171  
Torneira Stillus Prática de  
Parede 25° Black 1/4 de Volta - DN 15

CÓDIGO

28159



13cm  
11cm  
20cm

1171  
Torneira Stillus Prática Baixa  
de Mesa Black 1/4 de Volta - DN 15

CÓDIGO

27381



28cm  
17cm  
31cm

1171  
Torneira Stillus Prática Alta  
de Mesa 75° Black 1/4 de Volta - DN 15

CÓDIGO

27380



29cm  
18,5cm  
32cm

1171  
Torneira Stillus Prática Alta  
de Mesa 90° Black 1/4 de Volta - DN 15

CÓDIGO

27386



LINHA

# STILLUS PRÁTICA GOLD

**AGUIA**  
METAIS

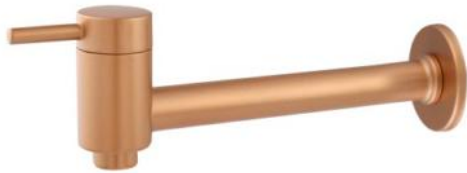

18cm

1171  
Torneira Stillus Prática Gold de  
Parede Reta 1/4 de Volta - DN 15

CÓDIGO

28507



19cm

1171  
Torneira Stillus Prática Gold de  
Parede 25° 1/4 de Volta - DN 15

CÓDIGO

28551



13cm  
11cm  
20cm

1171  
Torneira Stillus Prática Gold Baixa  
de Mesa 1/4 de Volta - DN 15

CÓDIGO

28431



28cm  
17cm  
31cm

1171  
Torneira Stillus Prática Gold Alta  
de Mesa 75° 1/4 de Volta - DN 15

CÓDIGO

28438



29cm  
18,5cm  
32cm

1171  
Torneira Stillus Prática Gold Alta  
de Mesa 90° 1/4 de Volta - DN 15

CÓDIGO

28441



LINHA

# STILLUS PRÁTICA ROSE

**AGUIA**  
METAIS

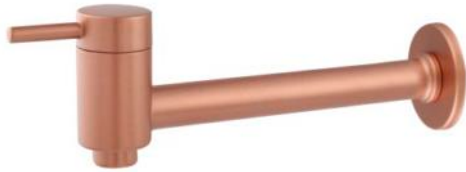

18cm

1171  
Torneira Stillus Prática Rose de  
Parede Reta 1/4 de Volta - DN 15

**CÓDIGO**

28508



19cm

1171  
Torneira Stillus Prática Rose de  
Parede 25° 1/4 de Volta - DN 15

**CÓDIGO**

28552



13cm  
11cm  
20cm

1171  
Torneira Stillus Prática Rose Baixa  
de Mesa 1/4 de Volta - DN 15

**CÓDIGO**

28437



28cm  
17cm  
31cm

1171  
Torneira Stillus Prática Rose Alta  
de Mesa 75° 1/4 de Volta - DN 15

**CÓDIGO**

28439



29cm  
18,5cm  
32cm

1171  
Torneira Stillus Prática Rose Alta  
de Mesa 90° 1/4 de Volta - DN 15

**CÓDIGO**

28442



LINHA

# STILLUS FIT



1171  
Torneira Stillus Fit  
Bica baixa de Mesa

**CÓDIGO**  
23362



1171  
Torneira Stillus Fit  
Bica Alta de Mesa 90°

**CÓDIGO**  
23359

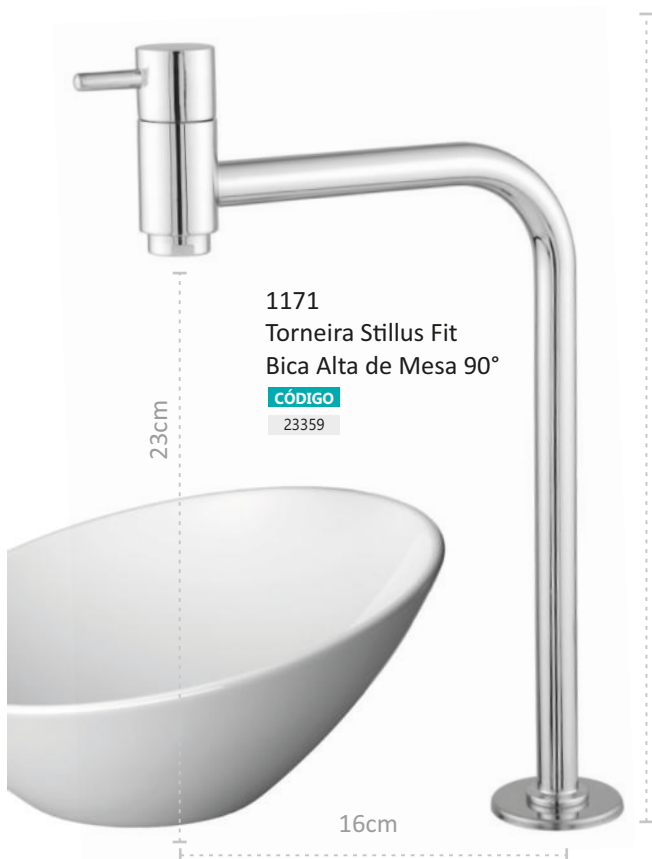

1171  
Torneira Stillus Fit  
Bica Alta de Mesa 75°

**CÓDIGO**  
23356





LINHA  
**CLÍNICA** TORNEIRAS



1165  
Torneira Elegance Clínica  
Giratória de Parede

**CÓDIGO**

7936



1198  
Torneira Elegance Clínica  
Giratória de Mesa p/ Lavatório

**CÓDIGO**

19404



1171  
Torneira Stillus Clínica  
de Parede 25°

**CÓDIGO**

9024



1171  
Torneira Stillus Clínica  
de Parede Reta

**CÓDIGO**

9025



1171  
Torneira Stillus Clínica  
Baixa de Mesa

**CÓDIGO**

9023



1171  
Torneira Stillus Clínica  
Alta de Mesa 75°

**CÓDIGO**

9021



1171  
Torneira Stillus Clínica  
Alta de Mesa 90°

**CÓDIGO**

9022



# LINHA ELEGANCE TORNEIRAS



**1158**  
Torneira Elegance p/  
Pia de Parede 18cm

CÓDIGO	
C31	3000
C34	3010
C40	3020
C52	3083
C55	18732
C60	18730
C70	18549



**1165**  
Torneira Elegance  
Giratória de Parede

S/ AREJ.	C/ AREJ.
C31	3077 3078
C34	299 282
C40	313 296
C52	298 281
C55	18736 18737
C60	18735 18734
C70	18550 18733



**1167**  
Torneira Elegance  
Giratória de Parede Baixa

S/ AREJ.	C/ AREJ.
C31	3011 3031
C34	3012 3032
C40	3013 3023
C52	3019 3039
C55	18745 18743
C60	18744 18742
C70	18554 18553



**1167**  
Torneira Elegance  
Giratória de Parede

S/ AREJ.	C/ AREJ.
C31	3001 3021
C34	3002 3022
C40	3003 3023
C52	3009 3029
C55	18741 18740
C60	18739 18738
C70	18552 18551



**1168**  
Torneira Elegance  
Giratória de Mesa

S/ AREJ.	C/ AREJ.
C31	346 331
C34	347 329
C40	341 324
C52	437 330
C55	18747 18749
C60	18746 18748
C70	18556 18555



**1198**  
Torneira Elegance  
Giratória de  
Mesa p/ Lavatório

S/ AREJ.	C/ AREJ.
C31	374 358
C34	373 357
C40	379 363
C52	438 356
C55	18753 18751
C60	18752 18750
C70	18558 18557



**1739**  
Ducha Higiênica  
Elegance

CÓDIGO	
C31	3053
C34	3054
C40	24372
C52	3061
C55	19063
C60	19064
C70	19065



LINHA

# ELEGANCE ACESSÓRIOS PARA BANHEIRO



6600  
Acessórios para Banheiro 05 Peças Elegance **CÓDIGO** 11911



6560-Banho  
Porta Toalha de Banho Elegance

**CÓDIGO**  
983



6560  
Porta Toalha de Rosto Elegance

**CÓDIGO**  
984



6530  
Saboneteira Elegance

**CÓDIGO**  
1010



6540  
Papeleira Elegance

**CÓDIGO**  
985



6580  
Cabide Elegance

**CÓDIGO**  
1099



6620  
Porta Shampoo Elegance

**CÓDIGO**  
1044

LINHA  
**ELEGANCE**  
DUCHAS E ACABAMENTOS



**1875**  
Misturador Elegance de Mesa  
Mecanismo 1416 1/4 de Volta

CÓDIGO	
C31	3064
C34	3066
C52	3065
C55	18757
C60	18759
C70	18760



**1876**  
Misturador Elegance de Parede  
Mecanismo 1416 1/4 de Volta

CÓDIGO	
C31	3067
C34	3066
C52	3068
C55	18761
C60	18762
C70	18763



**1875**  
Ducha Higiênica Misturador Elegance de Parede  
Mecanismo 1416 1/4 de Volta

CÓDIGO	
C31	24375
C34	3074
C52	3085
C55	18066
C60	19067
C70	19068



**1875**  
Acabamento Elegance  
p/ Registro

CÓDIGO	
C31	280
C34	279
C52	278
C55	19069
C60	19070
C70	19071



**1739**  
Ducha Articulada  
Elegance 3 Funções

CÓDIGO
3084



**1739**  
Ducha Articulada  
Elegance Master

CÓDIGO
3080





# LINHA COLOR SHOWER



	AZUL	PRETO	VERM.
C31	22761	22817	22801
C34	22764	22819	22803
C40	22766	22821	22805
C52	22772	22825	22809
C55	22778	22827	22811
C60	22780	22829	22813
C70	22782	22831	22814

**6800**  
Torneira Color Shower  
para Cozinha de Parede



	AZUL	PRETO	VERM.
C31	22760	22816	22800
C34	22763	22818	22802
C40	22765	22820	22804
C52	22771	22824	22808
C55	22776	22826	22810
C60	22779	22828	22812
C70	22781	22830	22815

**6800**  
Torneira Color Shower  
para Cozinha de Mesa



	AZUL		PRETO		VERM.	
	FILTRO ABS	FILTRO METAL	FILTRO ABS	FILTRO METAL	FILTRO ABS	FILTRO METAL
C31	22928	22935	22970	22977	22956	22963
C34	22929	22936	22971	22978	22957	22964
C40	22930	22937	22972	22979	22958	22965
C50	22932	22939	22974	22981	22960	22967
C52	22933	22940	22975	22982	22961	22968
C75	22934	22941	22976	22983	22962	22969

**2167**  
Torneira Color Shower  
de Parede com Filtro  
Metal ou ABS



	AZUL		PRETO		VERM.	
	FILTRO ABS	FILTRO METAL	FILTRO ABS	FILTRO METAL	FILTRO ABS	FILTRO METAL
C31	22984	22991	23012	23019	23026	23033
C34	22985	22992	23013	23020	23027	23034
C40	22986	22993	23014	23021	23028	23035
C50	22988	22995	23016	23023	23030	23037
C52	22989	22996	23017	23024	23031	23038
C75	22990	22997	23018	23025	23032	23039

**2168**  
Torneira Color Shower  
de Mesa com Filtro  
Metal ou ABS



TUBO INTERNO  
FLEXÍVEL DE SILICONE

MOLA AÇO  
INOX 304

CAPA MOLA  
LATÃO CROMADO

REVESTIMENTO  
SILICONE SOFT TOUCH

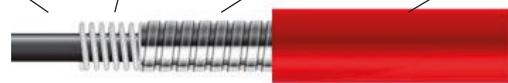

C31



C34



C40



C50



C52



C55



C60



C70



C75

# LINHA COLOR SHOWER

DUCHA CROMADA



	AZUL	PRETO	VERM.
C31	25033	25047	25061
C34	25034	25048	25062
C40	25035	25053	25068
C52	25037	25049	25063
C55	25036	25050	25064
C60	25038	25051	25065
C70	25039	25052	25066

**6820**  
Torneira Color Shower  
Ducha Cromada de Mesa



	AZUL	PRETO	VERM.
C31	25040	25054	25069
C34	25041	25055	25070
C40	25042	25060	25067
C52	25043	25056	25071
C55	25044	25057	25072
C60	25045	25058	25073
C70	25046	25059	25074

**6820**  
Torneira Color Shower  
Ducha Cromada de Parede



	AZUL		PRETO		VERM.	
	FILTRO ABS	FILTRO METAL	FILTRO ABS	FILTRO METAL	FILTRO ABS	FILTRO METAL
C31	25113	25119	25125	25131	25137	25143
C34	25114	25120	25126	25132	25138	25144
C40	25115	25121	25127	25133	25139	25145
C50	25116	25122	25128	25134	25140	25146
C52	25117	25123	25129	25135	25141	25147
C75	25118	25124	25130	25136	25142	25148

**2168**  
Torneira Color Shower  
Ducha Cromada com Filtro  
Mesa



	AZUL		PRETO		VERM.	
	FILTRO ABS	FILTRO METAL	FILTRO ABS	FILTRO METAL	FILTRO ABS	FILTRO METAL
C31	25075	25082	25089	25095	25101	25107
C34	25076	25083	25090	25096	25102	25108
C40	25077	25085	25091	25097	25103	25109
C50	25078	25086	25092	25098	25104	25110
C52	25080	25087	25093	25099	25105	25111
C75	25081	25088	25094	25100	25106	25112

**2167**  
Torneira Color Shower  
Ducha Cromada com Filtro  
Parede

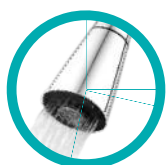

C31



C34



C40



C50



C52



C55



C60



C70



C75

LINHA  
**COLOR FLEX  
BLACK**



6700  
Torneira Color Flex  
Preto Parede C60 1/4 de Volta  
Black - Blister

**CÓDIGO**

27373



6700  
Torneira Color Flex  
Preto Mesa C60 1/4 de Volta  
Black - Blister

**CÓDIGO**

27375



# LINHA COLOR FLEX



6700  
Torneira Color Flex  
de Mesa para Cozinha



	AZUL		BRANCO		PRETO		VERM.	
	SACOLA	BLISTER	SACOLA	BLISTER	SACOLA	BLISTER	SACOLA	BLISTER
C31	21370	21252	22725	22723	21378	21261	21386	21269
C34	21371	21254	22724	22729	21379	21262	21387	21270
C40TC	21372	21255	22744	22730	21380	21263	21388	21271
C40TP	21373	21256	22746	-	21381	-	21389	-
C52	21374	21257	22748	22734	21382	21265	21390	21273
C55	21375	21258	22750	22736	21383	21266	21391	21274
C60	21376	21259	22752	22738	21384	21267	21392	21275
C70	21377	21260	22754	22740	21385	21268	21393	21276

6700  
Torneira Color Flex  
de Parede para Cozinha



	AZUL		BRANCO		PRETO		VERM.	
	SACOLA	BLISTER	SACOLA	BLISTER	SACOLA	BLISTER	SACOLA	BLISTER
C31	21343	21228	22726	22724	21351	21244	21362	21236
C34	21344	21229	22743	22728	21352	21245	21363	21237
C40TC	21345	21230	22745	22731	21353	21246	21364	21238
C40TP	21346	21231	22747	-	21354	-	21365	-
C52	21347	21232	22749	22735	21355	21248	21366	21240
C55	21348	21233	22751	22737	21359	21249	21367	21241
C60	21349	21234	22753	22739	21360	21250	21368	21242
C70	21350	21235	22755	22741	21361	21251	21369	21243

2167  
Torneira Color Flex  
de Parede com Filtro Metal  
ou ABS



	AZUL		BRANCO		PRETO		VERM.	
	FILTRO ABS	FILTRO METAL	FILTRO ABS	FILTRO METAL	FILTRO ABS	FILTRO METAL	FILTRO ABS	FILTRO METAL
C31	21720	21727	21734	21741	21748	21755	21762	21769
C34	21721	21728	21735	21742	21749	21756	21763	21770
C40	21722	21729	21736	21743	21750	21757	21764	21771
C50	21725	21731	21738	21745	21752	21759	21766	21773
C52	21724	21732	21739	21746	21753	21760	21767	21774
C75	21726	21733	21740	21747	21754	21761	21768	21775

2168  
Torneira Color Flex  
de Mesa com Filtro Metal  
ou ABS



	AZUL		BRANCO		PRETO		VERM.	
	FILTRO ABS	FILTRO METAL	FILTRO ABS	FILTRO METAL	FILTRO ABS	FILTRO METAL	FILTRO ABS	FILTRO METAL
C31	21776	21783	21792	21799	21828	21835	21842	21849
C34	21777	21784	21793	21800	21829	21836	21843	21850
C40	21778	21785	21794	21801	21830	21837	21844	21851
C50	21780	21787	21796	21803	21832	21839	21846	21853
C52	21781	21788	21797	21804	21833	21840	21847	21854
C75	21782	21789	21798	21805	21834	21841	21848	21855

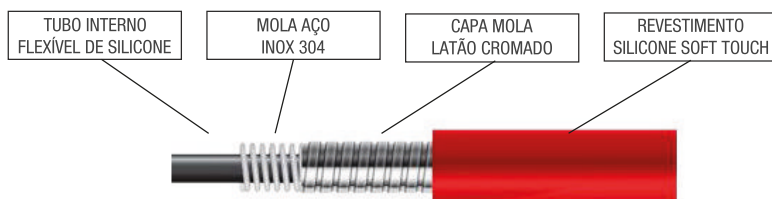

LINHA

# GOURMET SHOWER

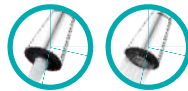

CROMADA



**CÓDIGO**

C31	23949
C34	23951
C40	23953
C52	23959
C55	23961
C60	23963
C70	23965

**6800**  
Torneira Gourmet Shower  
Cromada de Mesa p/ Cozinha



**CÓDIGO**

C31	23950
C34	23952
C40	23956
C52	23960
C55	23962
C60	23964
C70	23966

**6800**  
Torneira Gourmet Shower  
Cromada de Parede p/ Cozinha



**FILTRO ABS    FILTRO METAL**

C31	24295	24311
C34	24296	24312
C40	24297	24318
C52	24299	24315
C55	24300	24316
C75	24301	24317

**2167**  
Torneira Gourmet Shower Cromada  
de Parede p/ Cozinha com Filtro



**FILTRO ABS    FILTRO METAL**

C31	24302	24321
C34	24305	24322
C40	24309	24326
C52	24306	24323
C55	24307	24324
C75	24308	24325

**2168**  
Torneira Gourmet Shower Cromada  
de Mesa p/ Cozinha com Filtro



C31



C34



C40



C50



C52



C55



C60



C70

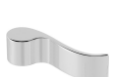

C75



LINHA

# GOURMET



CROMADA



	SACOLA	BLISTER
C31	16828	20972
C34	16704	20968
C40	16705	20970
C52	20204	21055
C55	17230	20974
C60	17232	20976
C70	17231	20978

**6500**  
Torneira Gourmet p/ Cozinha de Parede



	SACOLA	BLISTER
C31	16827	20971
C34	16428	20966
C40	16543	20967
C52	20203	20979
C55	17235	20973
C60	17236	20975
C70	17234	20977

**6500**  
Torneira Gourmet p/ Cozinha de Mesa



	FILTRO ABS		FILTRO METAL	
	1/4 VOL.	VED.	1/4 VOL.	VED.
C31	18975	18982	18968	18988
C33	18976	18983	18969	18989
C34	19612	-	19613	-
C40	18977	18984	18970	18990
C50	18978	18985	18971	18991
C52	18979	18986	18972	18992
C75	18980	-	18973	-

**2167**  
Torneira Gourmet Giratória p/ Cozinha de Parede c/ Filtro Metal ou ABS Ved.



	FILTRO ABS		FILTRO METAL	
	1/4 VOL.	VED.	1/4 VOL.	VED.
C31	18994	19009	19002	19015
C33	18995	19010	19003	19016
C34	19610	-	19611	-
C40	18996	19011	19004	19017
C50	18997	19012	19005	19018
C52	18998	19013	19006	19019
C75	18999	-	19007	-

**2168**  
Torneira Gourmet Giratória p/ Cozinha de Mesa c/ Filtro Metal ou ABS Ved.



LINHA  
**GOURMET**



6500  
Torneira Gourmet Cozinha  
Parede Chrome

**CÓDIGO**  
27128



6500  
Torneira Gourmet Cozinha  
Parede Black/Bronze

**CÓDIGO**  
27129

LINHA

# COLOR SHOWER FIT



	AZUL	PRETO	VERM.
C31	24670	24685	24699
C34	24671	24686	24700
C40	24677	24687	24701
C50	24672	24688	24702
C52	24673	24689	24703
C75	24674	24690	24704
C90	24675	24691	24705

**6810**  
Torneira Color Shower Fit  
de Mesa

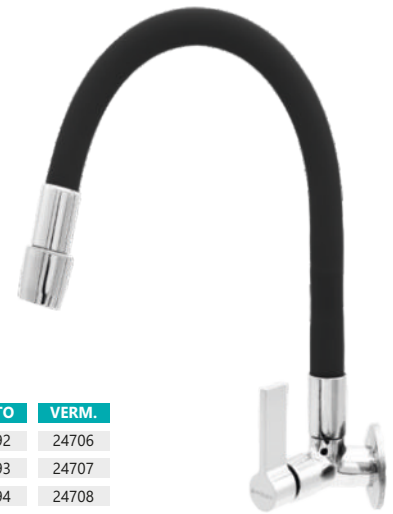

	AZUL	PRETO	VERM.
C31	24678	24692	24706
C34	24679	24693	24707
C40	24680	24694	24708
C50	24681	24695	24709
C52	24682	24696	24710
C75	24683	24697	24711
C90	24684	24698	24712

**6810**  
Torneira Color Shower Fit  
de Parede



	AZUL		PRETO		VERM.	
	FILTRO ABS	FILTRO METAL	FILTRO ABS	FILTRO METAL	FILTRO ABS	FILTRO METAL
C31	24996	25003	25010	25015	25022	25027
C34	24997	25004	25011	25016	25023	25028
C40	24994	24995	25008	25009	25020	25021
C50	24999	25005	25012	25017	25024	25029
C52	25000	25006	25013	25018	25025	25030
C75	25002	25007	25014	25019	25026	25031

**2168**  
Torneira Color Shower Fit  
de Mesa com Filtro  
ABS / Metal



	AZUL		PRETO		VERM.	
	FILTRO ABS	FILTRO METAL	FILTRO ABS	FILTRO METAL	FILTRO ABS	FILTRO METAL
C31	24950	24958	24972	24977	24984	24989
C34	24951	24959	24973	24978	24985	24990
C40	24952	24960	24970	24971	24982	24983
C50	24953	24967	24974	24979	24986	24991
C52	24954	24968	24975	24980	24987	24992
C75	24955	24969	24976	24981	24988	24993

**2167**  
Torneira Color Shower Fit  
de Parede com Filtro  
ABS / Metal



C31



C34



C40



C50



C52



C75



C90

# LINHA COLOR FLEX FIT



	AZUL	PRETO	VERM.
C31	24627	24641	24634
C34	24628	24642	24635
C40	24629	24643	24636
C50	24630	24644	24637
C52	24631	24645	24638
C75	24632	24646	24639
C90	24633	24647	24640

**6710**  
Torneira Color Flex Fit  
de Mesa



	AZUL	PRETO	VERM.
C31	24648	24655	24663
C34	24649	24656	24664
C40	24650	24657	24665
C50	24651	24658	24666
C52	24652	24659	24667
C75	24653	24660	24668
C90	24654	24662	24669

**6710**  
Torneira Color Flex Fit  
de Parede



	AZUL		PRETO		VERM.	
	FILTRO ABS	FILTRO METAL	FILTRO ABS	FILTRO METAL	FILTRO ABS	FILTRO METAL
C31	24911	24917	24924	24930	24936	24942
C34	24912	24918	24925	24931	24937	24943
C40	24913	24920	24926	24932	24938	24944
C50	24914	24921	24927	24933	24939	24945
C52	24915	24922	24928	24934	24940	24946
C75	24916	24923	24929	24935	24941	24947

**2168**  
Torneira Color Flex Fit  
de Mesa com Filtro  
ABS / Metal



	AZUL		PRETO		VERM.	
	FILTRO ABS	FILTRO METAL	FILTRO ABS	FILTRO METAL	FILTRO ABS	FILTRO METAL
C31	24843	24876	24882	24888	24895	24905
C34	24844	24875	24883	24889	24898	24906
C40	24845	24877	24884	24890	24901	24907
C50	24870	24879	24885	24891	24902	24908
C52	24871	24880	24886	24892	24903	24909
C75	24872	24881	24887	24893	24904	24910

**2167**  
Torneira Color Flex Fit  
de Parede com Filtro  
ABS / Metal



C31



C34



C40



C50



C52



C75



C90

LINHA

# GOURMET SHOWER FIT



CÓDIGO	
C31	25149
C34	25150
C40	25151
C50	25152
C52	25153
C75	25154
C90	25809

**6830**  
Torneira Gourmet Shower  
Fit de Mesa



CÓDIGO	
C31	25155
C34	25156
C40	25157
C50	25158
C52	25159
C75	25160
C90	25810

**6830**  
Torneira Gourmet Shower  
Fit de Parede



	FILTRO ABS	FILTRO METAL
C31	25174	25180
C34	25175	25181
C40	25176	25182
C50	25177	25183
C52	25178	25184
C75	25179	25185

**2168**  
Torneira Gourmet Shower  
Fit de Mesa



	FILTRO ABS	FILTRO METAL
C31	25161	25167
C34	25162	25168
C40	25163	25170
C50	25164	25171
C52	25165	25172
C75	25166	25173

**2167**  
Torneira Gourmet Shower  
Fit de Parede

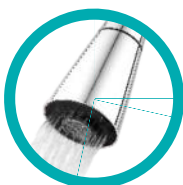

C31

C34

C40

C50

C52

C75

# LINHA GOURMET FIT



### SACOLA

C31	22834
C33	22836
C34	22838
C40	22842
C50	22846
C52	22848
C75	22850
C90	23049

**6510**  
Torneira Gourmet Fit de Parede p/ Cozinha



### SACOLA

C31	22833
C33	22835
C34	22837
C40	22839
C50	22845
C52	22847
C75	22849
C90	23048

**6510**  
Torneira Gourmet Fit p/ Cozinha de Mesa



### FILTRO ABS    FILTRO METAL

C31	22890	22895
C34	22891	22896
C40	22892	22897
C50	22907	22906
C52	22893	22898
C75	22894	22899
C90	26271	26272

**2167**  
Torneira Gourmet Fit de Parede p/ Cozinha com Filtro



### FILTRO ABS    FILTRO METAL

C31	22900	22908
C34	22901	22909
C40	22902	22910
C50	22903	22911
C52	22904	22912
C75	22905	22913
C90	26290	26292

**2168**  
Torneira Gourmet Fit de Mesa p/ Cozinha com Filtro



LINHA

**PREMIUM** TUBO 3/4"

**AGUIA**  
METAIS



	C/ AREJ. ARTIC.		S/ AREJ. ARTIC.	
	SACOLA	BLISTER	SACOLA	BLISTER
C31	15733	1473	15740	1427
C34	15734	8383	15741	8382
C40	15736	1476	15743	1430
C50	15739	1480	15746	1434
C52	15735	1481	15742	1584
C55	18812	18809	18806	18803
C60	18813	18810	18807	17052
C70	18814	18811	18808	18805

**1167**  
Torneira Premium  
Giratória p/ Cozinha  
de Parede Bica Baixa



	C/ AREJ. ARTIC.		S/ AREJ. ARTIC.	
	SACOLA	BLISTER	SACOLA	BLISTER
C31	15716	1464	15726	1418
C34	15719	7008	15727	7009
C40	15721	1467	15729	1421
C50	15724	1471	15732	1425
C52	15720	1472	15728	1426
C55	18800	18797	18794	18791
C60	18801	18798	18795	18792
C70	18802	18799	18796	18793

**1167**  
Torneira Premium  
Giratória p/ Cozinha  
de Mesa



	C/ AREJ. ARTIC.		S/ AREJ. ARTIC.	
	SACOLA	BLISTER	SACOLA	BLISTER
C31	15756	532	15749	1401
C34	15757	7010	15750	8074
C40	15759	13234	15752	1404
C50	15762	8030	15755	1408
C52	15758	531	15751	1409
C55	18818	18815	18824	18821
C60	18819	18816	18825	18822
C70	18820	18817	18826	18823

**1168**  
Torneira Premium  
Giratória p/ Cozinha  
de Mesa



	C/ AREJ. ARTIC.		S/ AREJ. ARTIC.	
	SACOLA	BLISTER	SACOLA	BLISTER
C31	15770	534	15763	1390
C34	15772	8075	15764	7012
C40	15774	13235	15766	1393
C50	15777	8029	15769	1397
C52	15773	533	15765	1398
C55	18830	18827	18837	18833
C60	18831	18828	18838	18835
C70	18832	18829	18839	18836

**1198**  
Torneira Premium  
Giratória p/ Lavatório  
de Mesa



1739  
Ducha Articulada  
Premium

**CÓDIGO**  
8540



6600  
Acessórios p/ Banheiro 05 Peças Premium

**CÓDIGO**  
7317



6560  
Porta Toalha de Rosto Premium

**CÓDIGO**  
19280



6530  
Saboneteira Premium

**CÓDIGO**  
19282



6540  
Papeleira Premium

**CÓDIGO**  
19283



6580  
Cabide Premium

**CÓDIGO**  
19281



6560-Banho  
Porta Toalha de Banho Premium

**CÓDIGO**  
19279



**1167**  
Torneira Flat Giratória  
de Parede para Cozinha  
(Sacola)

**CÓDIGO**

C31	23097
C33	23098
C34	23099
C40	23100
C50	23102
C52	23103
C75	23104
C90	26540



**1168**  
Torneira Flat Giratória  
de Mesa para Cozinha  
(Sacola)

**CÓDIGO**

C31	23105
C33	23106
C34	23107
C40	23108
C50	23110
C52	23111
C75	23112
C90	26541



**1198**  
Torneira Flat Giratória  
para Lavatório  
(Sacola)

**CÓDIGO**

C31	23113
C33	23114
C34	23115
C40	23116
C50	23118
C52	23119
C75	23120
C90	26542



C31



C33



C34



C40



C50



C52



C75



C90

# LINHA CLASSIC



1167  
Torneira Classic  
Giratória p/ Cozinha  
de Parede Bica Baixa

	C/ AREJ. ARTIC.		S/ AREJ. ARTIC.	
	SACOLA	BLISTER	SACOLA	BLISTER
C31	23183	16470		
C33	23186	16471		
C34	23187	15905		
C40	23188	16475		
C50	23189	16474		
C52	23190	16473		
C75	23191	18854		
C90	25952	25954		



1167  
Torneira Classic  
Giratória p/ Cozinha  
de Parede

	C/ AREJ. ARTIC.		S/ AREJ. ARTIC.	
	SACOLA	BLISTER	SACOLA	BLISTER
C31	19763	24465	15257	613
C33	19764	24466	15449	615
C34	19765	21035	15450	1166
C40	19766	24467	15453	617
C50	19767	24458	15258	1139
C52	19768	24469	15451	1141
C75	19769	20849	18855	18852
C90	25952	25951	24784	25950



1167  
Torneira Bica Móvel  
Alta Max  
de Parede

	C/ AREJ. ARTIC.		S/ AREJ. ARTIC.	
	SACOLA	BLISTER	SACOLA	BLISTER
C23	27558		27557	
C31	27560		27559	
C33	27562		27561	
C34	27564		27563	
C40	27566		27565	
C50	27568		27567	
C52	27570		27569	
C75	27573		27571	
C90	27575		27574	



1168  
Torneira Classic  
Giratória p/ Cozinha  
de Mesa

	C/ AREJ. ARTIC.		S/ AREJ. ARTIC.	
	SACOLA	BLISTER	SACOLA	BLISTER
C31	19930	24459	15260	1438
C33	19931	24460	15456	1439
C34	19932	21039	15457	1440
C40	19933	24461	15461	1442
C50	19934	24463	15261	1446
C52	19935	24464	15458	1447
C75	19936	20850	18857	18856
C90	25957	25956	24782	25955



1168  
Torneira Bica Móvel  
Alta Max  
de Mesa

	C/ AREJ. ARTIC.		S/ AREJ. ARTIC.	
	SACOLA	BLISTER	SACOLA	BLISTER
C23	27626		27625	
C31	27628		27627	
C33	27631		27630	
C34	27633		27632	
C40	27635		27634	
C50	27637		27636	
C52	27639		27638	
C75	27641		27640	
C90	27643		27642	



	CÓDIGO	
C31	6491	
C34	1485	
C40	1459	
C50	1483	
C52	1484	
C55	20874	
C60	24456	
C70	24457	
C75	18842	
C90	25963	

1876  
Misturador Classic  
Giratório de Mesa /  
Parede com Arej.  
Articulado



# LINHA CLASSIC FILTROS



2168  
Torneira p/ Cozinha de Mesa Classic c/  
Filtro Metal ou ABS

	FILTRO ABS		FILTRO METAL	
	C/ AREJ. ARTIC.	S/ AREJ. ARTIC.	C/ AREJ. ARTIC.	S/ AREJ. ARTIC.
C31	20682	20681	20683	18504
C33	24470	24472	24471	24473
C34	20684	19853	20685	20287
C40	20692	20690	20693	20691
C50	20699	20698	20701	20700
C52	20686	20625	20687	20624
C75	20688	18966	20689	18964
C90	25977	25976	25979	25978



2167  
Torneira Classic Giratória de parede c/  
Filtro Metal ou ABS

	FILTRO ABS		FILTRO METAL	
	C/ AREJ. ARTIC.	S/ AREJ. ARTIC.	C/ AREJ. ARTIC.	S/ AREJ. ARTIC.
C31	10634	1718	10632	1682
C33	10652	1720	10638	1684
C34	10655	9156	10654	9155
C40	10662	1722	10658	1686
C50	10674	1732	10672	1696
C52	10678	1734	10676	1698
C75	18846	18845	18844	18843
C90	25969	25968	25973	25972



2167  
Torneira Classic Giratória Bica Baixa  
de parede c/ Filtro Metal ou ABS

	FILTRO ABS		FILTRO METAL	
	C/ AREJ. ARTIC.	S/ AREJ. ARTIC.	C/ AREJ. ARTIC.	S/ AREJ. ARTIC.
C31	-	1719	10633	1683
C33	10653	1721	10651	1685
C34	10657	10631	10656	10630
C40	10663	1723	10659	1687
C50	10675	1733	10673	1697
C52	10679	1735	10677	1699
C75	18851	18850	18849	18847
C90	25971	25970	25975	25974



2159  
Torneira p/ Cozinha de Parede Classic  
Fixa c/ Filtro Metal ou ABS

	FILTRO ABS	FILTRO METAL
	C31	18887
C33	18888	18895
C34	20378	20379
C40	18889	18897
C50	8860	8859
C52	18891	18900
C75	18892	18901
C90	25966	25967



2147  
Torneira Filtro Classic de Parede  
c/ Filtro Metal ou ABS

	FILTRO ABS	FILTRO METAL
	C23	19021
C31	19022	19029
C33	19023	19030
C34	24484	24485
C40	19024	19031
C50	19025	19032
C52	19026	19033
C75	19027	19034
C90	25964	25965



1148  
Adaptador p/ Filtro Classic

	CÓDIGO
	C31
C33	9330
C34	18712
C40	9331
C50	9334
C52	9335
C75	24483
C90	25936



# LINHA CLASSIC



	COMUM		C/ BICO		C/ AREJADOR	
	SACOLA	BLISTER	SACOLA	BLISTER	SACOLA	BLISTER
C23	26000		27278		27890	
C31	26001		27280		27892	
C33	26002		27282		27896	
C34	26003		27290		27899	
C40	26004		27291		27902	
C50	26005		27293		27906	
C52	26015		27295		27910	

**1158**  
Torneira Classic  
p/ Pia Fit 15cm



	COMUM		C/ BICO		C/ AREJADOR	
	SACOLA	BLISTER	SACOLA	BLISTER	SACOLA	BLISTER
C23	17243	6198	17364	6216	17356	6226
C31	17379	6202	17367	6223	17357	6229
C33	17378	6203	17366	6263	17358	6264
C34	16778	10251	17371	10252	17363	10250
C40	17380	6206	17368	6267	17360	6269
C50	17382	6215	17370	6277	17362	6278
C52	24474	24477	24475	24478	24476	24479
C55	20423	-	20424	-	20425	-
C75	18865	18864	18863	18862	18861	18860
C90	25938	25937	25942	25941	25940	25939

**1158**  
Torneira Classic  
p/ Pia 18cm



	COMUM		C/ BICO		C/ AREJADOR	
	SACOLA	BLISTER	SACOLA	BLISTER	SACOLA	BLISTER
C23	18960	7166	18961	7169	18959	7170
C31	16869	7172	16885	7174	16877	7176
C33	16870	7178	16887	7180	16878	7182
C34	16871	14007	16888	14006	16879	14008
C40	16872	7187	16889	7188	16880	7189
C50	16875	7193	16892	7194	16883	7195
C52	16876	24480	16893	24481	16884	24482
C75	18869	18867	18871	18866	18870	18868
C90	25944	25943	25948	25947	25946	25945

**1159**  
Torneira Classic  
p/ Pia 22cm



**6220**  
Torneira Tipo Cree

**CÓDIGO**  
622



	SACOLA	BLISTER
C23	17253	7168
C31	17252	7171
C33	17255	7173
C34	17260	10462
C40	17258	7175
C50	17254	7181
C52	17257	7184
C75	18877	18876
C90	25933	25932

**1428**  
Torneira Classic  
p/ Máquina de Lavar  
1/2 x 3/4



	SACOLA	BLISTER
C23	16257	6288
C31	16258	6289
C33	16259	6290
C34	16260	16253
C40	16261	6292
C50	16265	6296
C52	16266	7137
C75	18875	18874
C90	25935	25934

**1132**  
Torneira Classic  
p/ Jardim Cromada  
c/ Bico 1/2 x 3/4



	SACOLA
C23	7197
C31	7198
C33	7199
C34	17815
C40	7201
C50	7203
C52	7204
C75	18878
C90	25960

**1427**  
Registro Classic  
p/ Máquina de Lavar  
1/2 x 3/4



# LINHA CLASSIC



**1875**  
Misturador Classic p/  
Lavatório de Mesa  
Cano Alto Mecanismo  
1416 1/4 de Volta

CÓDIGO	
C31	9252
C34	8987
C40	9255
C50	9253
C52	9254
C55	18841
C60	24454
C70	24455
C75	24453
C90	25961



**1875**  
Misturador Classic p/  
Lavatório de Mesa

CÓDIGO	
C31	1241
C34	1240
C40	24438
C50	24449
C52	1242
C55	24450
C60	24451
C70	24452
C75	18840
C90	25962



**1198**  
Torneira Classic  
Giratória p/  
Lavatório de Mesa

	SACOLA	BLISTER
C31	15412	1145
C33	15443	1146
C34	15413	1147
C40	15446	1152
C50	15264	1158
C52	15444	1159
C75	18859	18858
C90	24785	25959

**1739**  
Ducha Higiênica  
Classic

	SACOLA	BLISTER
C31	16933	11959
C33	16934	11960
C34	16931	4865
C40	16935	11962
C50	16938	11966
C52	16939	11967
C55	-	22671
C60	-	21101
C75	20868	20867
C90	25808	25807



LINHA  
**CLASSIC**  
LAVATÓRIO



1193  
Torneira Classic  
p/ Lavatório de Mesa

	SACOLA	BLISTER
C23	18879	1198
C31	18880	1200
C33	18881	1199
C34	20297	18872
C40	18882	1202
C50	18884	1210
C75	20368	18873



1194  
Torneira Classic  
p/ Lavatório de Mesa

	CAIXA
C31	20171
C33	20172
C34	20173
C40	20174
C50	20175
C52	23270
C75	22674
C90	25958



1091  
Torneira Classic  
p/ Lavatório de Mesa

	SACOLA	CAIXA
C31	15692	15687
C33	15693	3058
C34	24490	24487
C40	15694	15690
C50	15696	15691
C52	24491	24488
C75	24492	24489
C91	15697	1867



1092  
Torneira Classic  
p/ Lavatório de Mesa

	CAIXA
C31	1808
C33	1809
C34	17015
C40	1810
C50	1815
C52	1801
C75	24493



1196  
Torneira Classic  
p/ Lavatório de Mesa

	1/4	MVS
C31	1816	1378
C33	1817	838
C34	21000	-
C40	1819	177
C50	1823	181
C52	1800	821
C75	24486	-



1199  
Torneira Classic  
p/ Lavatório de Mesa

	1/4	MVS
C31	1843	1379
C33	1844	1177
C40	1846	183
C50	1850	187
C52	1851	822



C23



C31



C33



C34



C40



C50



C52



C75



C90

# LINHA AUTOMATIQUE



1170  
Torneira Automatique  
p/ Lavatório

**CÓDIGO**

1016



1172  
Torneira Automatique  
p/ Lavatório

**CÓDIGO**

1384



1177  
Torneira Automatique  
p/ Lavatório

**BLISTER SACOLA**

17917

17923



1173  
Torneira Automatique  
p/ Lavatório

**CÓDIGO**

1385



1174  
Torneira  
Automatique  
p/ Lavatório

**BLISTER SACOLA**

1386

22168



1175  
Torneira  
Automatique  
de Parede Reta

**CÓDIGO**

1387



1178  
Torneira Automatique  
p/ Lavatório

**BLISTER SACOLA**

26421

26424



1176  
Válvula para  
Mictório Automatique

**CÓDIGO**

1388



LINHA  
**FILTROS**  
VEDANTES



2167  
Torneira Giratória p/  
Cozinha Bica Baixa de  
Parede c/ Filtro Metal  
ou ABS Ved.

	FILTRO ABS		FILTRO METAL	
	C/ AREJ. ARTIC.	S/ AREJ. ARTIC.	C/ AREJ. ARTIC.	S/ AREJ. ARTIC.
C23	-	24494	-	24495
C31	1673	1517	1601	1509
C33	1674	490	1602	450
C40	1676	477	1604	452
C50	1680	502	1608	456
C52	1681	503	1609	457



2167  
Torneira Giratória p/  
Cozinha de Parede c/  
Filtro Metal ou ABS  
Ved.

	FILTRO ABS		FILTRO METAL	
	C/ AREJ. ARTIC.	S/ AREJ. ARTIC.	C/ AREJ. ARTIC.	S/ AREJ. ARTIC.
C23	17275	17086	-	17103
C31	1664	1516	1592	1508
C33	1665	458	1593	442
C40	1667	492	1595	444
C50	1671	496	1599	448
C52	1672	497	1600	449



2168  
Torneira Giratória p/  
Cozinha de Parede  
c/ Filtro Metal  
ou ABS Ved.

	FILTRO ABS		FILTRO METAL	
	C/ AREJ. ARTIC.	S/ AREJ. ARTIC.	C/ AREJ. ARTIC.	S/ AREJ. ARTIC.
C23	20104	19183	20111	19176
C31	20105	19184	20112	19177
C33	20106	19185	20113	19178
C40	20107	19186	20114	19179
C50	20108	19188	20115	19181
C52	20110	19189	20116	19182



2159  
Torneira Fixa Cozinha  
de Parede c/ Filtro  
Metal ou ABS Ved.

	FILTRO ABS	FILTRO METAL
	C23	1027
C31	1534	506
C33	522	554
C40	527	511
C50	525	509
C52	592	595





2147  
Torneira  
Filtro ABS  
ou Metal Ved.

	FILTRO ABS	FILTRO METAL
C23	17695	17682
C31	17696	17683
C33	17727	17684
C40	17729	17686
C50	17731	17689
C52	17732	17685



7110  
Copo p/ Filtro  
Metal ou ABS s/ Vela

ABS	METAL
13925	17036



7110  
Copo p/ Filtro  
Metal ou ABS com  
Vela

ABS	METAL
711	713



1147  
Adaptadorzinho  
p/ Filtro Ved.

CÓDIGO	
C23	686
C31	1539
C33	687
C40	827
C50	690
C52	832



1148  
Adaptador  
p/ Filtro Ved.

CÓDIGO	
C23	691
C31	1541
C33	692
C40	693
C50	695
C52	918



Convencional  
714



Convencional Certificada  
13842

7140  
Refil Filtrante



Blindada Pró Saúde  
17241



Blindada Pró Saúde Certificada  
26416

7140  
Refil Filtrante



C23



C31



C33



C40



C50



C52

LINHA  
**LAVATÓRIO**  
VEDANTE



1192  
Torneira p/  
Lavatório Comando  
Único Metal ou ABS

CÓDIGO	
	1449



1198  
Torneira Giratória  
p/ Lavatório de  
Mesa Ved.

CÓDIGO	
C23	16453
C31	1382
C33	188
C40TC	190
C40TP	189
C50	194
C52	203

1193  
Torneira p/  
Lavatório  
Ved.

CÓDIGO	
C23	159
C31	1374
C33	160
C40TC	757
C40TP	606
C50	163
C52	11247



1194  
Torneira p/  
Lavatório  
Ved.

	VED.	MVS
C23	17005	-
C31	1375	1376
C33	870	837
C40TC	872	165
C40TP	871	-
C50	876	169
C52	877	781



1195  
Torneira p/  
Lavatório  
Ved.

CÓDIGO	
C31	1377
C33	878
C40TC	171
C40TP	170
C50	175
C52	820



C23



C31



C33



C40



C50



C52

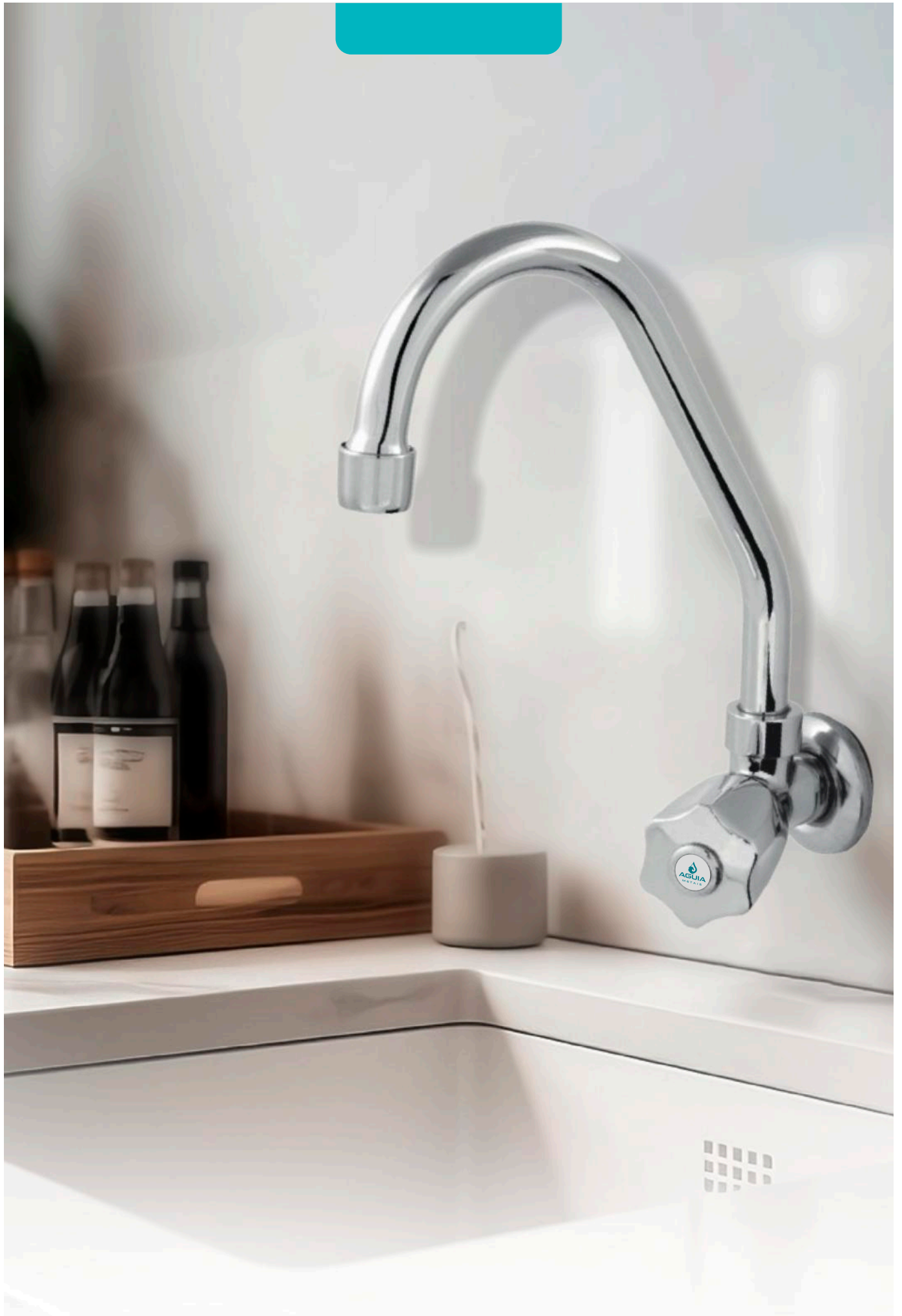



**1167**  
Torneira Giratória  
p/ Cozinha Cano  
tipo "S" Parede MVS

	AREJ. ART.	C/ ROSCA
C31	1454	-
C33	886	-
C40TC	889	19758
C40TP	888	-
C50	850	-
C52	887	19759

**1168**  
Torneira Giratória  
p/ Cozinha de Mesa  
Vedante

	C/ AREJ. ART.	S/ AREJ. ART.
C23	19938	8673
C31	10723	1399
C33	8674	204
C40TC	8893	206
C40TP	8892	205
C50	1021	210
C52	19943	211



**1167**  
Torneira Bica Móvel  
Alta Max  
de Parede

	AREJ. ART.	C/ ROSCA
C23	27526	27425
C31	27528	27530
C33	27547	27548
C40	27549	27550
C50	27552	27551
C52	27553	27554



**1168**  
Torneira Bica Móvel  
Alta Max  
de Mesa

	AREJ. ART.	C/ ROSCA
C23	27644	2646
C31	27646	27647
C33	27648	27649
C40	27650	27651
C50	27652	27653
C52	27654	27655



**1167**  
Torneira Giratória  
p/ Cozinha Parede  
Bica Baixa  
Vedante

	C/ AREJ. ART.	S/ AREJ. ART.
C23	-	16451
C31	-	1411
C33	316	252
C40TC	318	254
C40TP	317	253
C50	322	258
C52	323	259



**1167**  
Torneira Giratória  
p/ Cozinha de Parede  
Vedante

	C/ AREJ. ART.	S/ AREJ. ART.	C/ ROSCA
C23	-	982	-
C31	1457	1410	1500
C33	284	220	348
C40TC	286	222	-
C40TP	285	221	-
C50	290	226	354
C52	291	227	355



**1467**  
Torneira Giratória  
Parede c/ saída  
3/4" c/  
Red. 1/2"x3/4"

	CLASS.	VED.	LE 1/4 VOLT.	LE VED.
C23	-	24739	24732	24727
C31	24713	24740	24733	24725
C33	24714	24741	24734	24728
C34	24719	-	24735	-
C40	24720	24742	24736	24730
C50	24721	24743	24737	24731
C52	24722	24744	-	-
C75	24723	-	-	-
C90	24724	-	-	-



C23



C31



C33



C40



C50



C52

# LINHA TANQUE / JARDIM



Opções de Bico:



	COMUM	COM AREJADOR	C/ BICO
C23	26006	27889	27279
C31	26008	27891	27281
C33	26009	27895	27289
C40	26010	27901	27292
C50	26011	27905	27294
C52	26016	27909	27296

1158  
Torneira p/ Pia Fit  
15cm Vedante

Opções de Bico:



	COMUM	COM AREJADOR	C/ BICO
C23	99	119	109
C31	1362	1365	1364
C33	100	120	110
C40TC	758	121	111
C40TP	131	798	792
C50	103	123	113
C52	11210	16998	16996

1158  
Torneira p/ Pia  
18cm Vedante

Opções de Bico:



	COMUM	COM AREJADOR	C/ BICO
C23	129	149	139
C31	1368	1371	1370
C33	130	150	140
C40TC	760	151	141
C40TP	804	816	810
C50	133	153	143
C52	16999	17001	17000

1159  
Torneira p/ Pia  
22cm Vedante



1120  
Torneira para Tanque  
Cromada ou Amarela  
1/2" ou 3/4" ved.

	1/2"		3/4"	
	CROM.	AMA.	CROM.	AMA.
	002	001	006	005



1126  
Torneira para Tanque  
Cromada ou Amarela  
1/2" ou 3/4" ved.

	CROMADA		AMARELA	
	1/2"	3/4"	1/2"	3/4"
C23	011	015	-	-
C33	012	016	-	-
CHAV.	010	014	009	013



1128  
Torneira para Jardim  
Crom. c/ Bico Crom.  
ou Am. 1/2" Ved.

	CROM.	AMA.
C23	16993	-
C33	21952	-
CHAV.	026	025



1130  
Torneira para Jardim  
Cromada ou Amarela  
1/2" ou 3/4" ved.

	CROM.	AMA.
C23	858	-
C31	1018	-
C33	863	-
CHAV.	028	027



C23

C31

C33

C40

C50

C52



**1428**  
Torneira p/ Máq.  
Lavar 1/2" x 3/4"  
Vedante

CÓDIGO	
C23	602
C31	1543
C33	603
C40TC	1545
C40TP	1544
C50	604
C52	1548
CHAV.	1806



**1132**  
Torneira p/ Jardim  
Cromada c/ Bico  
Metal 1/2" x 3/4"  
Vedante

CÓDIGO	
C23	860
C31	1349
C33	861
C40TC	901
C40TP	899
C50	904
C52	543



**1427**  
Registro para  
Máquina de Lavar  
1/2" x 3/4" Ved.

CÓDIGO	
C23	973
C31	974
C33	975
C40TC	977
C40TP	976
C50	981
C52	9306



**1122**  
Torneira para  
Bebedouro  
Cromada 4,8cm  
MVS 1/2"

CÓDIGO	
C23	27502
C33	27507
C34	27506
C50	27504
C55	27505



**1417**  
Torneira de Esfera  
Vazão Total

1/2" x 3/4"	3/4"
4755	4756



**1417**  
Torneira de Esfera  
Vazão Total Latão  
1/2" x 3/4" c/ Red. 3/4"

CÓDIGO
26590



**1417**  
Torneira de Jardim com  
Porta Cadeado  
1/2" x 3/4" Com Red. 3/4"

CÓDIGO
23276



**1427**  
Registro de Esfera p/  
Máquina de Lavar  
1/2" x 3/4" Com Red. 3/4"

CÓDIGO
23279



C23



C31



C33



C40



C50



C52

LINHA

# LE PREMIUM

ACABAMENTO EM ABS CANO METAL



**1167 PREMIUM**  
Torneira LE Premium  
Giratória Bica Baixa  
p/ Cozinha de Parede

	C/ AREJ. ARTIC.	S/ AREJ. ARTIC.
C23	24499	24500
C31	15787	15791
C33	15822	15815
C34	21869	21872
C40	15788	15792
C50	15790	15794



**1167 PREMIUM**  
Torneira LE Premium  
Giratória p/ Cozinha  
de Parede

	C/ AREJ. ARTIC.	S/ AREJ. ARTIC.
C31	15778	15783
C33	15821	15816
C34	21873	21870
C40	15779	15784
C50	15781	15786



**1168 PREMIUM**  
Torneira LE Premium  
Giratória p/ Cozinha  
de Mesa

	C/ AREJ. ARTIC.	S/ AREJ. ARTIC.
C23	19042	19041
C31	15799	15795
C33	15814	15813
C34	21875	21874
C40	15800	15796
C50	15802	15798



**1198 PREMIUM**  
Torneira LE Premium  
Giratória p/ Lavatório  
de Mesa

	C/ AREJ. ARTIC.	S/ AREJ. ARTIC.
C23	24498	24497
C31	15807	15803
C33	15812	15811
C34	21878	21877
C40	15808	15804
C50	15810	15823



1167  
Torneira LE Giratória  
p/ Cozinha de Parede

	1/4 DE VOLTA	VEDANTE
C23	19036	19035
C31	15373	13499
C33	15374	13500
C34	21812	-
C40TC	15483	15484
C40TP	15519	15520
C50	15375	13366



1168  
Torneira LE Giratória  
p/ Cozinha de Mesa

	1/4 DE VOLTA	VEDANTE
C23	19208	18936
C31	15376	13497
C33	15377	13498
C34	21813	-
C40TC	15485	15486
C40TP	15521	15522
C50	15378	13370



2167  
Torneira LE  
Giratória  
p/ Cozinha  
c/ Filtro  
de Parede

	FILTRO ABS	
	1/4 DE VOLTA	VEDANTE
C23	21640	19047
C31	21644	14093
C33	21643	14094
C34	21653	-
C40TC	21645	15500
C40TP	21646	15535
C50	21647	13372



2168  
Torneira LE  
Giratória  
p/ Cozinha  
c/ Filtro  
de Mesa

	FILTRO ABS	
	1/4 DE VOLTA	VEDANTE
C23	21661	-
C31	21663	15338
C33	21665	15339
C34	21666	-
C40TC	21667	15502
C40TP	21668	15537
C50	21669	15340



2159  
Torneira LE  
Cozinha de  
Parede Fixa  
c/ Filtro ABS

	FILTRO ABS	
	1/4 DE VOLTA	VEDANTE
C23	21678	21677
C31	21679	15329
C33	21680	15330
C34	21681	-
C40TC	21682	15497
C40TP	21683	15534
C50	21684	15331

2147  
Torneira LE Filtro ABS

	FILTRO ABS	
	1/4 DE VOLTA	VEDANTE
C23	21694	21693
C31	21695	17726
C33	21696	17728
C34	21697	-
C40TC	21698	17733
C40TP	21699	17734
C50	21700	24434



1147  
AdaptadorzinhoLE  
p/ Filtro

	CÓDIGO
C23	20679
C31	15344
C33	15345
C40TC	15476
C40TP	15512
C50	15347





**1158**  
Torneira LE Fit  
p/ Pia 15cm  
1/2" x 3/4"

	COMUM		C/ BICO		C/ AREJADOR	
	1/4 VOL.	VED.	1/4 VOL.	VED.	1/4 VOL.	VED.
C23	25988	25994	27298	27299	27887	27888
C31	25989	25995	27300	27301	27893	27894
C33	25990	25997	27302	27303	27897	27898
C34	25991	-	27304	-	27900	-
C40	25992	25998	27305	27306	27903	27904
C50	25993	25999	27307	27309	27907	27908



**1158**  
Torneira LE p/  
Pia 18cm  
1/2"X3/4"

	COMUM		C/ BICO		C/ AREJADOR	
	1/4 VOL.	VED.	1/4 VOL.	VED.	1/4 VOL.	VED.
C23	22057	1779	22066	18664	22074	18663
C31	22060	14125	22068	15306	22075	15302
C33	22061	1778	22069	15307	22076	15303
C34	22062	-	22070	-	22077	-
C40TC	22063	15477	22071	15478	22078	15479
C40TP	22064	15515	22072	15514	22079	15513
C50	22065	14126	22073	15308	22080	15305

Opções de Bico:



**1159**  
Torneira LE p/  
Pia 22cm  
1/2"X3/4"

	COMUM		C/ BICO		C/ AREJADOR	
	1/4 VOL.	VED.	1/4 VOL.	VED.	1/4 VOL.	VED.
C23	22083	18669	22090	18673	22097	18672
C31	22084	15309	22091	15316	22098	15312
C33	22085	15310	22092	15318	22099	15313
C34	22086	-	22093	-	22100	-
C40TC	22087	15480	22094	15482	22101	15481
C40TP	22088	15517	22095	15518	22102	15516
C50	22089	15311	22096	15320	22103	15314



**1132**  
Torneira p/  
Jardim LE  
Cromada

	1/4 VOLTA	VEDANTE
	C23	22028
C31	15892	15886
C33	15893	15887
C34	21979	-
C40TC	15894	15888
C40TP	15895	15889
C50	15896	15890



**1428**  
Torneira LE  
p/ Máq. Lavar  
1/2"x3/4"

	1/4 VOLTA	VEDANTE
	C23	21991
C31	21992	14127
C33	21993	11827
C34	21994	-
C40TC	21995	15495
C40TP	21996	15531
C50	21997	-





**1092**  
Torneira LE p/  
Lavatório de Mesa

	1/4 VOLT.	MVS
C23	19052	19058
C31	19053	19386
C33	19054	19059
C34	21862	-
C40TC	19055	19060
C50	19056	19061



**1194**  
Torneira LE p/ Lavatório  
de Mesa

	1/4 VOLTA	VEDANTE
C23	22110	19062
C31	22111	15323
C33	22112	15324
C34	22113	-
C40TC	22114	15488
C40TP	22115	15524
C50	22116	15325



**1193**  
Torneira LE p/ Lavatório  
de Mesa

	1/4 VOLTA	VEDANTE
C23	18913	18917
C31	22104	14095
C33	22105	14096
C34	22106	-
C40TC	22107	15487
C40TP	22108	15523
C50	22109	14098



**1198**  
Torneira LE p/ Lavatório  
de Mesa

	1/4 VOLTA	VEDANTE
C23	19044	19043
C31	15379	13496
C33	15380	13494
C34	21814	-
C40TC	15489	15490
C40TP	15526	15525
C50	15381	13371



**1739**  
Ducha Higiênica  
LE

	GAT. BRANCO		GAT. CROMADO	
	1/4 VOL.	VED.	1/4 VOL.	VED.
C23	22124	18596	22117	18589
C31	22125	14118	22118	18590
C33	22126	14120	22119	18591
C34	22127	-	22120	-
C40TC	22128	15496	22121	18592
C40TP	22129	15532	22122	18593
C50	22130	14123	22123	18594



C23



C31



C33



C34



C40



C50



1267  
Torneira Giratória  
Cozinha de parede ABS  
C31 1/4 de Volta

**CÓDIGO**  
25913



1268  
Torneira Giratória Cozinha  
de Mesa ABS  
C31 1/4 de Volta

**CÓDIGO**  
25914



1258  
Torneira de Pia Cozinha ABS Cromada  
1/4 de Volta c/ Bico C31

**CÓDIGO**  
25911



1258  
Torneira de Pia Cozinha ABS Cromada  
1/4 de Volta c/ Arejador C31

**CÓDIGO**  
25912



1232  
Torneira p/ Jardim  
Cromada c/ Bico ABS  
C31 1/4 de Volta

**CÓDIGO**  
25910



1228  
Torneira Máquina de  
Lavar Cromada ABS  
C31 1/4 de Volta

**CÓDIGO**  
25916



1192  
Torneira p/  
Lavatório Comando  
Único Metal ou ABS

**CÓDIGO**  
20051



1298  
Torneira Giratória  
Lavatório ABS Cromada  
C31 1/4 de Volta

**CÓDIGO**  
25915



C31

# REGISTROS DE PRESSÃO

1400  
Registro de Pressão  
c/ Chaveta Vedante  
DN15 - 1/2"  
DN20 - 3/4"



	1/2"	3/4"
BRUTO	037	038
C23	039	041
C31	21209	21210
C33	040	042

1403  
Registro de Pressão  
Bruto Vedante  
DN15 - 1/2"  
DN20 - 3/4"



	1/2"	3/4"
BRUTO	779	780
C23	783	785
C33	784	786

1413  
Registro de Pressão  
Vedante Canopla ABS  
DN15 - 1/2"  
DN20 - 3/4"



	1/2"	3/4"
C23	1052	1053
C31	1055	1054
C33	1056	1057
C40TC	1060	1061
C40TP	1058	1059
C50	1069	1068
C52	1070	1071

2416  
Base para Registro de Pressão  
DN15 - 1/2"  
DN20 - 3/4"



	CÓDIGO
3/4" SOFT (PISTÃO AMARELO)	16227
3/4" SOFT (PISTÃO CROMADO)	16226
3/4" VEDANTE ABNT (PISTÃO CROMADO)	1051
3/4" MVS (PISTÃO CROMADO)	1049
3/4" 1/4 DE VOLTA (PISTÃO CROMADO)	394
1/2" MVS (PISTÃO CROMADO)	1050
1/2" VEDANTE (PISTÃO AMARELO)	16225
1/2" VEDANTE (PISTÃO CROMADO)	1009

1416  
Registro de Pressão  
Vedante Canopla  
Metal ou ABS  
DN15 - 1/2"  
DN20 - 3/4"



	1/2"		3/4"	
	ABS	METAL	ABS	METAL
C23	1754	043	1765	051
C31	1757	1354	1767	-
C33	1755	044	1766	052
C40TC	1758	046	1770	054
C40TP	1759	045	1769	053
C50	1763	050	1776	058
C52	1764	851	1777	843

REPARO  
ABNT

1416  
Registro de Pressão 3/4"  
1/4 de Volta Metal  
ou ABS



	ABS	METAL
C31	1231	421
C33	1232	420
C34	14129	8354
C40TC	1234	411
C40TP	1233	408
C50	1238	406
C52	1239	405
C55	22704	19074
C60	22705	19075
C70	22706	19076
C75	21900	19077

REPARO



C23

C31

C33

C34

C40

C50

C52

C55

C60

C70

C75

# REGISTROS

DE PRESSÃO



1416  
Registro de Pressão 1/2"  
e 3/4" Vedante Soft Canopla  
Metal ou ABS

	1/2" VEDANTE		3/4" SOFT	
	ABS	METAL	ABS	METAL
C23	1754	043	16211	20945
C31	1757	1354	16212	20946
C33	1755	044	16213	20947
C40TC	1758	046	16214	20948
C50	1763	050	16217	20951
C52	1764	851	16218	20952
C55	-	-	22037	-



1416  
Registro de Pressão 1/2"  
e 3/4" MVS Soft Canopla  
Metal ou ABS

	1/2"		3/4"	
	ABS	METAL	ABS	METAL
C23	1868	059	1220	067
C31	1870	1356	1222	1357
C33	1869	060	1221	068
C40TC	1873	062	1224	070
C50	1877	066	1228	074
C52	1878	864	1229	828



1417  
Registro Esfera Vazão  
Total

BITOLA	CÓDIGO
1"	567
1.1/2"	568
1/2"	565
2"	574
2.1/2"	569
3"	570
3/4"	566
4"	571

# REGISTROS

DE PRESSÃO LE



1400  
Registro de Pressão LE  
1/2" ou 3/4" Vedante  
DN15 - 1/2"  
DN20 - 3/4"

	1/2"	3/4"
C23	22038	22040
C31	15348	15351
C33	15349	15352
C40TC	15491	15492
C50	15350	15354



1416  
Registro de Pressão LE  
3/4" Vedante Corpo ABNT  
DN20 - 3/4"

	3/4"
C23	18942
C31	15370
C33	15371
C40TC	15494
C50	15372



1416  
Registro de Pressão Soft LE  
1/2" ou 3/4" Vedante  
DN15 - 1/2"  
DN20 - 3/4"

	1/2"	3/4"
C23	-	18920
C31	15367	16219
C33	15368	16220
C40TC	15493	16221
C40TP	15529	16222
C50	-	16223



# REGISTROS

DE GAVETA



1509  
Registro de  
Gaveta Bruto  
Pistão 7/16

Tamanhos:  
DN15 - 1/2"  
DN20 - 3/4"  
DN25 - 1"  
DN32 - 1.1/4"  
Dn40 - 1.1/2"



	1/2"	3/4"	1"	1.1/4"	1.1/2"
BRUTO	764	075	083	1168	091
C23	1329	076	084	928	092
C31	1358	1359	1360	1361	936
C33	1330	077	085	929	093
C40TC	1332	080	088	931	096
C40TP	1331	079	087	930	095
C42	20190	20191	-	-	-
C50	1336	078	086	1167	094
C52	1337	841	867	935	869

2509  
Base p/  
Registro

Tamanhos:  
DN15 - 1/2"  
DN20 - 3/4"  
DN25 - 1"  
DN32 - 1.1/4"  
Dn40 - 1.1/2"



	1/2"	3/4"	1"	1.1/4"	1.1/2"
AMARELO	11115	11128	11141	11154	11167
CROMADO	11116	11129	11142	11155	11168

## ACABAMENTOS PARA REGISTROS LE

1554  
Acabamento LE  
C23 p/ Registro

1/2", 3/4", 1"	20759
1.1/4", 1.1/2"	20758



1554  
Acabamento LE  
C31 p/ Registro

1/2", 3/4", 1"	17996
1.1/4", 1.1/2"	17995



1554  
Acabamento LE  
C33 p/ Registro

1/2", 3/4", 1"	17997
1.1/4", 1.1/2"	17998



1554  
Acabamento LE  
C34 p/ Registro

1/2", 3/4", 1"	24435
1.1/4", 1.1/2"	24436



1554  
Acabamento LE  
C40TP e C40TC  
p/ Registro

C40TP	
1/2", 3/4", 1"	17994
1.1/4", 1.1/2"	17993
C40TC	
1/2", 3/4", 1"	17992
1.1/4", 1.1/2"	17991



1554  
Acabamento LE  
C50 p/ Registro

1/2", 3/4", 1"	16838
1.1/4", 1.1/2"	16832



C23

C31

C33

C34

C40

C50

C52

C70

# ACABAMENTOS PARA REGISTROS



1554  
Acabamento C23 p/ Reg.  
Canopla Metal ou ABS

	1/2", 3/4", 1"		1.1/4", 1.1/2"	
	SACOLA	BLISTER	SACOLA	BLISTER
ABS	9354	6764	9380	6763
METAL	-	11868	-	11878



1554  
Acabamento C31 p/ Reg.  
Canopla Metal ou ABS

	1/2", 3/4", 1"		1.1/4", 1.1/2"	
	SACOLA	BLISTER	SACOLA	BLISTER
ABS	9357	581	15162	5801
METAL	-	5801	-	1564



1554  
Acabamento C33 p/ Reg.  
Canopla Metal ou ABS

	1/2", 3/4", 1"		1.1/4", 1.1/2"	
	SACOLA	BLISTER	SACOLA	BLISTER
ABS	9361	583	9358	582
METAL	-	638	-	646

1554  
Acabamento  
C40TC ou C40TP  
p/ Reg. Canopla  
Metal ou ABS



TC	1/2", 3/4", 1"		1.1/4", 1.1/2"	
	SACOLA	BLISTER	SACOLA	BLISTER
ABS	9366	585	9364	584
METAL	-	640	-	648

TP	1/2", 3/4", 1"		1.1/4", 1.1/2"	
	SACOLA	BLISTER	SACOLA	BLISTER
ABS	9369	591	15163	590
METAL	-	639	-	-

1554  
Acabamento C50 p/ Reg.  
Canopla Metal ou ABS



	1/2", 3/4", 1"		1.1/4", 1.1/2"	
	SACOLA	BLISTER	SACOLA	BLISTER
ABS	9375	595	9373	594
METAL	-	644	-	652

1554  
Acabamento C52 p/ Reg.  
Canopla Metal ou ABS



	1/2", 3/4", 1"		1.1/4", 1.1/2"	
	SACOLA	BLISTER	SACOLA	BLISTER
ABS	9379	597	9377	596
METAL	-	844	-	893



1554  
Acabamento C55 p/ Reg.  
Canopla Metal ou ABS

	1/2", 3/4", 1"		1.1/4", 1.1/2"	
	SACOLA	BLISTER	SACOLA	BLISTER
ABS	19376	24839	23129	23128
METAL	-	26436	-	23127



1554  
Acabamento C60 p/ Reg.  
Canopla Metal ou ABS

	1/2", 3/4", 1"		1.1/4", 1.1/2"	
	SACOLA	BLISTER	SACOLA	BLISTER
ABS	17034	-	24443	-
METAL	-	24445	-	24444



1554  
Acabamento C70 p/ Reg.  
Canopla Metal ou ABS

	1/2", 3/4", 1"		1.1/4", 1.1/2"	
	SACOLA	BLISTER	SACOLA	BLISTER
ABS	20313	-	24446	-
METAL	-	24448	-	24447



1554  
Acabamento C34 p/ Reg.  
Canopla Metal ou ABS

	1/2", 3/4", 1"		1.1/4", 1.1/2"	
	SACOLA	BLISTER	SACOLA	BLISTER
ABS	15165	8966	15164	8963
METAL	-	8965	-	8964

# ACABAMENTOS PARA REGISTROS



7005  
Acabamento Quadrat Cromado  
p/ Registro 1/2", 3/4" e 1"

CÓDIGO  
6997



7005  
Acabamento Quadrat Black  
p/ Registro 1/2", 3/4" e 1"

CÓDIGO  
27545



7005  
Acabamento Quadrat Gold Matte  
p/ Registro 1/2", 3/4" e 1"

CÓDIGO  
28228



7005  
Acabamento Quadrat Rose Matte  
p/ Registro 1/2", 3/4" e 1"

CÓDIGO  
28233

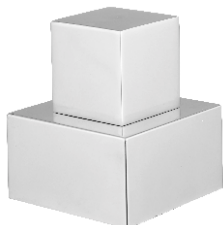

7005  
Acabamento  
Quadrat 1"1/2 Cromado

CÓDIGO  
28264



7005  
Acabamento  
Quadrat 1"1/2 Black Matte

CÓDIGO  
28484



7005  
Acabamento  
Quadrat 1"1/2 Gold Matte

CÓDIGO  
28482



7005  
Acabamento  
Quadrat 1"1/2 Rose Matte

CÓDIGO  
28483

EXCLUSIVO



# VOLANTES / CRUZETAS / ALAVANCAS



\*OPÇÃO LE

1654 Cruzeta C23

METAL	ABS
703	20712



1654 Trizeta C26

METAL	
26654	



1654 Trizeta C27

METAL	
770	



1654 Cruzeta C31

METAL	ABS
1587	16660

\*OPÇÃO LE



1654 Cruzeta C33

METAL	ABS
704	16662



1654 Cruzeta C52

METAL	
765	



1654 Cruzeta C55

METAL	
19078	



1654 Volante C40

TC	METAL	ABS
	706	16665
TP	METAL	ABS
	705	16666



1654 Volante C50

METAL	
710	



1654 Alavanca C34

METAL	
1243	



1654 Alavanca C60

METAL	
17171	



1654 Alavanca C69

METAL	
17170	



1654 Alavanca C70

METAL	
19079	



1654 Alavanca C75

METAL	
19080	



1654 Alavanca C79

METAL	
27760	



1654 Alavanca C90

METAL	
24593	



1654 Alavanca Stillus

STILLUS	
21099	
STILLUS PRÁTICA	
21100	

# DUCHAS



1739  
Ducha Articulada Redonda Black **CÓDIGO** 27715



1739  
Ducha Articulada Quadrat Cano Redondo Parede **CÓDIGO** 26202



1739  
Ducha Articulada Quadrat Cano Redondo de Teto **CÓDIGO** 26203



1739  
Ducha Articulada Tradicional **CÓDIGO** 552



1739  
Ducha Articulada Soft **CÓDIGO** 9002



1739  
Ducha Articulada 3 Funções **CÓDIGO** 551

1739  
Ducha Higiênica Gatilho Metal Vedante

	SACOLA	BLISTER
C23	1206	598
C31	1571	1569
C33	1207	599
C40TC	1572	601
C40TP	1208	600
C50	1575	767
C52	1576	769



1740  
Ducha Higiênica Soft Gatilho ABS

GATILHO BRANCO
231
GATILHO CROMADO
559



1741  
Ducha Higiênica Pop **CÓDIGO** 1486



# GATILHOS

7440  
Gatilho p/ Ducha Higiênica Metal

**CÓDIGO**  
744



7440  
Gatilho p/ Ducha Higiênica ABS Cromado

**CÓDIGO**  
229



7440  
Gatilho p/ Ducha Higiênica ABS Branco

**CÓDIGO**  
230



# ACESSÓRIOS

## SQUARE LUXO



6600  
Acessórios Square Luxo  
(Alumínio)

05 Peças 06 Peças

CÓDIGO

17053

CÓDIGO

20058



6530  
Saboneteira Square Luxo

CÓDIGO

17133



6580  
Cabide Square Luxo

CÓDIGO

17049



6540  
Papeleira Square Luxo

CÓDIGO

17085



Porta Shampoo  
Square Luxo

CÓDIGO

17106



6560  
Porta Toalha Rosto  
Square Luxo

CÓDIGO

17125



6560  
Porta Toalha Banho  
Square Luxo

CÓDIGO

17117

## SQUARE LUXO BLACK



6600  
Acessórios para  
Banheiro 5 Peças  
Square Luxo Black

CÓDIGO

27203

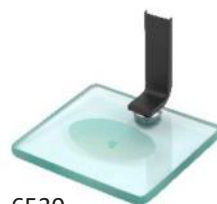

6530  
Saboneteira Square  
Luxo Black

CÓDIGO

27461



6580  
Cabide Square  
Luxo Black

CÓDIGO

27465



6540  
Papeleira Square  
Luxo Black

CÓDIGO

27462



6560  
Porta Toalha Rosto  
Square Luxo Black

CÓDIGO

27464



6560  
Porta Toalha Banho  
Square Luxo Black

CÓDIGO

27463

# ACESSÓRIOS

## ■ SQUARE LUXO GOLD MATTE



6600  
Acessórios para  
Banheiro 5 Peças  
Square Luxo Gold Matte

**CÓDIGO**  
28444



6530  
Soboneteira Square  
Luxo Gold Matte

**CÓDIGO**  
28744



6580  
Cabide Square  
Luxo Gold Matte

**CÓDIGO**  
28750



6540  
Papeleira Square  
Luxo Gold Matte

**CÓDIGO**  
28740



6560  
Porta Toalha Rosto  
Square Gold Matte

**CÓDIGO**  
28746



6560  
Porta Toalha Banho  
Square Gold Matte

**CÓDIGO**  
28748



## ■ SQUARE LUXO ROSE MATTE



6600  
Acessórios para  
Banheiro 5 Peças  
Square Luxo Rose Matte

**CÓDIGO**  
28407



6530  
Soboneteira Square  
Luxo Rose Matte

**CÓDIGO**  
28745



6580  
Cabide Square  
Luxo Rose Matte

**CÓDIGO**  
28751



6540  
Papeleira Square  
Luxo Rose Matte

**CÓDIGO**  
28741



6560  
Porta Toalha Rosto  
Square Luxo Rose Matte

**CÓDIGO**  
28747



6560  
Porta Toalha Banho  
Square Rose Matte

**CÓDIGO**  
28749



# ACESSÓRIOS

## SQUARE



6600  
Acessórios 05 Peças  
Square

CÓDIGO

18515



6530  
Saboneteira Square

CÓDIGO

19246



6580  
Cabide Square

CÓDIGO

19243



6540  
Papeleira Square

CÓDIGO

19245



6560  
Porta Toalha Rosto Square

CÓDIGO

19244



6560  
Porta Toalha Banho Square

CÓDIGO

19247

## SQUARE BLACK



6600  
Acessórios 05 Peças  
Square

CÓDIGO

27741



Saboneteira  
Square Black



Cabide Square  
Black



Papeleira  
Square Black



Porta Toalha  
Rosto Square  
Black



Porta Toalha Banho  
Square Black

# ACESSÓRIOS

## SQUARE GOLD



6600  
Acessórios 05 Peças  
Square Gold

CÓDIGO

28234



Saboneteira  
Square Gold



Cabide Square  
Gold



Papeleira  
Square Gold



Porta Toalha  
Rosto Square  
Gold



Porta Toalha Banho  
Square Gold

## SQUARE ROSE



6600  
Acessórios 05 Peças  
Square Rose

CÓDIGO

28235



Saboneteira  
Square Rose



Cabide Square  
Rose



Papeleira  
Square Rose



Porta Toalha  
Rosto Square  
Rose



Porta Toalha Banho  
Square Rose

# ACESSÓRIOS

## ■ MÔNACO



6600  
Acessórios 05 Peças  
Mônaco

**CÓDIGO**

16015



6530  
Saboneteira Mônaco

**CÓDIGO**

18250



6580  
Cabide Mônaco

**CÓDIGO**

18252



6540  
Papeleira Mônaco

**CÓDIGO**

18251

6560  
Porta Toalha  
Rosto Mônaco

**CÓDIGO**

18253



6560  
Porta Toalha Banho Mônaco

**CÓDIGO**

18254

## ■ VIENA CLASSIC



6600  
Acessórios 05 Peças  
Viena Classic

**CÓDIGO**

16554



6530  
Saboneteira Viena Classic

**CÓDIGO**

18238



6540  
Papeleira Viena Classic

**CÓDIGO**

18239



6580  
Cabide Viena Classic

**CÓDIGO**

18243

6560  
Porta Toalha  
Rosto Viena Classic

**CÓDIGO**

18240



6560  
Porta Toalha Banho  
Viena Classic

**CÓDIGO**

18241



# ACESSÓRIOS

## ■ KIT ÁGUA (LATÃO)



6600  
Acessórios 05 Peças Água

**CÓDIGO**  
11910



6530  
Saboneteira Água

**CÓDIGO**  
653



6540  
Papeleira c/ Tapa Água

**CÓDIGO**  
655



6580  
Cabide Duplo Água

**CÓDIGO**  
658



6560  
Porta Toalha **CÓDIGO**  
Argola Água 656



6560  
Porta Toalha Reto Água  
**CÓDIGO**  
657

## ■ LE



6600  
Acessórios 05 Peças LE

**CÓDIGO**  
2631



6530  
Saboneteira LE

**CÓDIGO**  
126



6540  
Papeleira c/ Tapa LE

**CÓDIGO**  
134



6580  
Cabide Duplo LE

**CÓDIGO**  
125



6560  
Porta Toalha **CÓDIGO**  
Argola LE 128

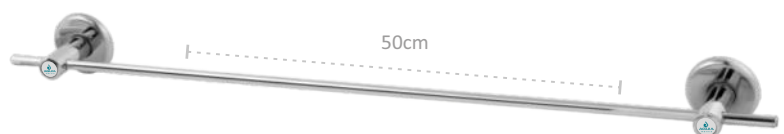

6560  
Porta Toalha **CÓDIGO**  
Reto LE 127

# ACESSÓRIOS

## JÚNIOR



6000  
Acessórios 05 Peças Júnior

**CÓDIGO**  
2208



6530  
Saboneteira Júnior

**CÓDIGO**  
126



6540  
Papeleira c/ Tampa Júnior

**CÓDIGO**  
134



6580  
Cabide Simples Júnior

**CÓDIGO**  
144



6560  
Porta Toalha  
Argola Júnior

**CÓDIGO**  
128

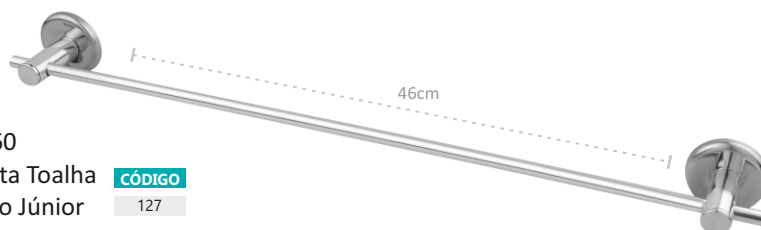

6560  
Porta Toalha  
Reto Júnior

**CÓDIGO**  
127

## FIT



6600  
Acessórios para  
Banheiro 5 Peças Fit

**CÓDIGO**  
27592



Cabide Simples  
Fit



Cabide Duplo  
Fit



Saboneteira  
Fit



Porta Toalha Rosto  
Fit



Papeleira  
Fit

# PORTA SHAMPOO

6620  
Porta Shampoo  
Canto Duplo c/  
Grade

**CÓDIGO**  
17099

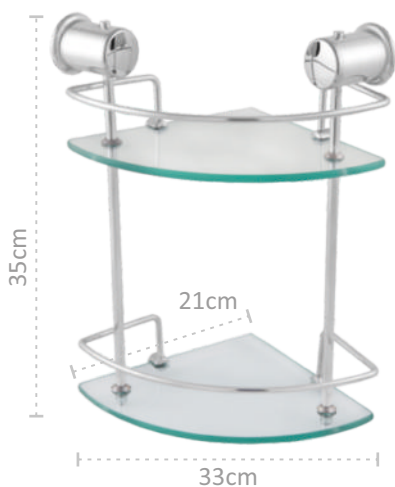

6620  
Porta Shampoo  
LE Reto Duplo c/  
Grade

**CÓDIGO**  
17101



6620  
Porta Shampoo  
LE de Canto

**CÓDIGO**  
389



6620  
Porta Shampoo  
LE Reto

**CÓDIGO**  
390



6620 Latão  
Porta Shampoo  
de Canto Cromado

**CÓDIGO**  
663

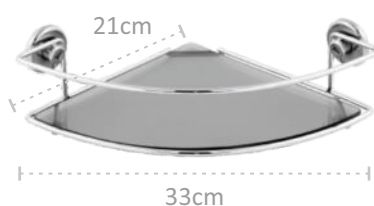

6620 Latão  
Porta Shampoo  
Reto Cromado

**CÓDIGO**  
662

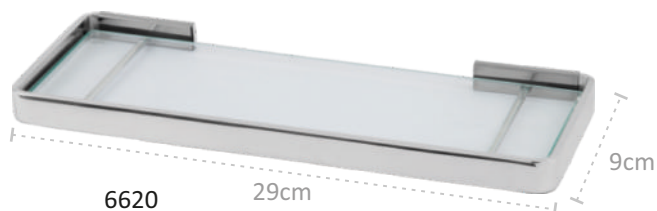
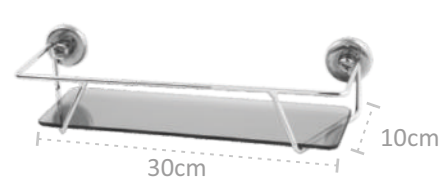

6620  
Porta Shampoo  
Square Luxo

**CÓDIGO**  
17106

# BANHEIRO COZINHA



1015 Metal  
Cabide 5 Ganchos

CÓDIGO

1015



1015  
Cabide 5 Ganchos LE

CÓDIGO

556



1015  
Cabide 4 Ganchos LE

CÓDIGO

557



9700  
Engate Flexível Cromado  
30 / 40 / 60 / 120 / 180cm

30cm 40cm 60cm

970 674 966

120cm 180cm

675 560



9700  
Engate Flexível Trançado  
30 / 40 / 60cm

30cm 40cm 60cm

1046 1017 1045



9700  
Engate Flexível Trançado  
p/ Misturador Monocomando

CÓDIGO

17051



9700  
Engate PVC Branco  
Flexível 60cm

CÓDIGO

27131



6560  
Porta Papel toalha LE

CÓDIGO

558



6540  
Papeleira sem Tampa LE

Alumínio Latão Cromado

135 655



8940  
Braço p/ Chuveiro Alumínio  
30cm - 40cm

30cm 40cm

894 895



1154  
Tubo de Ligação Ajustável  
25 / 30 / 35 / 40cm

LE LATÃO

25cm 30cm 35cm 40cm

262 263 1568 19912



1567  
Tubo de Ligação 25 / 30 cm

LE LATÃO

25cm 30cm 25cm 30cm

260 261 678 835



7810  
Sifão p/ Lavatório e Pia

CÓDIGO

425



7810  
SIFÃO PREMIUM P/ COZINHA 30CM X 1.1/2"

10766

SIFÃO PREMIUM P/ TANQUE 30CM X 1.1/4"

10764

SIFÃO PREMIUM P/ LAVATÓRIO 30CM X 7/8"

8878

ALÇAS DE

# APOIO

ALUMÍNIO POLIDO FIXADOR DE LATÃO



1011

Alça de Apoio LE em "U" - 1.1/4"  
para Lavatório - 45x55cm

**CÓDIGO**  
17042



1011

Alça de Apoio

30cm	40cm	50cm	60cm
576	577	578	579
70cm	80cm	90cm	100cm
19230	580	8670	21338

1011

Alça de Apoio LE Canto - 1.1/4"

**CÓDIGO**  
17041



1011

Alça de Apoio 90°  
60x60cm

**CÓDIGO**  
15901

1011

Alça de Apoio LE 45° - 1.1/4"

**60x60** **45x45**  
17038 17039

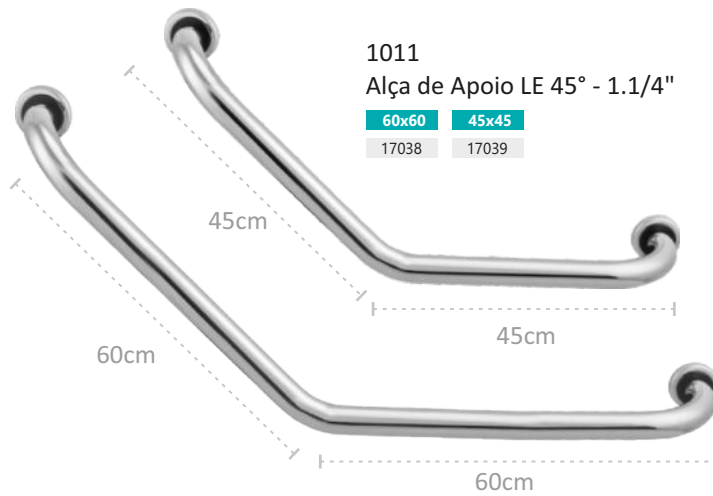

# RALOS E GRELHAS

1324  
Ralo Quadrado

10x10cm 15x15cm

664 665



1327  
Grelha Quadrada

10x10cm 15x15cm

666 667



1324  
Ralo Redondo

10cm 15cm

1324 1325



1327  
Grelha Redonda

10cm 15cm

1144 1327



1324  
Ralo Click

10x10

CÓDIGO

26163



# CONEXÕES

3001  
Luva de  
Redução  
1/2"x3/4"

CÓDIGO

17181



3001  
Luva  
1/2"

CÓDIGO

17180



3002  
Te de  
Redução  
1/2"x3/4"

CÓDIGO

17184



3002  
Te de  
1/2"

CÓDIGO

19085



3003  
Cotovelo  
1/2"

CÓDIGO

17179



3004  
União  
1/2"

CÓDIGO

17185



3005  
Niple  
1/2"

LATÃO CROMADO

22056

LATÃO

17182



# VÁLVULAS

1600  
Válvula p/ Pia em Metal  
c/ Unho - s/ Unho

SEM UNHO / TAMPA METAL	608
SEM UNHO / TAMPA BRANCA	679
COM UNHO / TAMPA BRANCA	680



1603  
Válvula p/ Lavatório Metal c/  
Unho - s/ Unho c/ Ladrão  
s/ Ladrão

COM UNHO / SEM LADRÃO	682
SEM UNHO / COM LADRÃO	684
SEM UNHO / COM LADRÃO	683
SEM UNHO / SEM LADRÃO	681
SEM UNHO / COM LADRÃO / TAMPA METAL	5951
SEM UNHO / SEM LADRÃO / TAMPA METAL	596



1603  
Válvula Inox p/ Lavatório  
2.1/2" com Tampa Plástica

CÓDIGO	10498
--------	-------



1603  
Válvula Inox p/ Lavatório  
2.1/2" com Tampa Inox

CÓDIGO	10500
--------	-------



1603  
Válvula p/ Lavatório ABS  
s/ Unho / s/ Ladrão Cromada

CÓDIGO	155
--------	-----



1603  
Válvula p/ Lavatório ABS  
s/ Unho / s/ Ladrão Branca

CÓDIGO	154
--------	-----



1623  
Válvula p/ Pia Americana  
ABS Cromada

CÓDIGO	157
--------	-----



1623  
Válvula p/ Pia Americana  
Metal c/ Cesto ABS ou Metal

ABS	685
METAL	575



1630  
Válvula p/ Tanque Metal  
1.1/4"

CÓDIGO	1842
--------	------



1623  
Válvula p/ Pia Americana  
ABS Branca

CÓDIGO	156
--------	-----



1623  
Válvula p/ Pia Americana  
Inox 3.1/2" c/ Pino Cromado

CÓDIGO	10598
--------	-------



1623  
Válvula p/ Pia Americana  
Inox 4.1/2" c/ Pino Cromado

CÓDIGO	10599
--------	-------

# VÁLVULAS



1603  
Válvula Longa p/ Pia CR  
s/ unho e s/ ladrão Latão

**CÓDIGO**

248



1603  
Válvula Click Metal p/  
Lavatório Pequeno 7/8"

**CÓDIGO**

27740



1603  
Válvula Click Metal p/  
Lavatório Grande 7/8"

**CÓDIGO**

17177



1630  
Válvula Click Metal p/  
Lavatório / Tanque 1.1/4"

**TAMPA GRANDE**

27960

**TAMPA PEQUENA**

17178



1603  
Válvula Click Black  
Lavatório 7/8"

**CÓDIGO**

26721



1603  
Válvula Click Gold  
Lavatório 7/8"

**CÓDIGO**

26722



1603  
Válvula Click  
Rose  
Lavatório 7/8"

**CÓDIGO**

26723



1630  
Válvula Click Black  
Lavatório / Tanque  
1.1/4"

**CÓDIGO**

26724



1630  
Válvula Click Gold  
Lavatório / Tanque  
1.1/4"

**CÓDIGO**

26725



1630  
Válvula Click Rose  
Lavatório / Tanque  
1.1/4"

**CÓDIGO**

26726

# PUXADORES

1011  
Puxador 90° 3/4"  
Cromado 30x30cm  
(Latão)

CÓDIGO 1014



1011  
Puxador  
3/4 Cromado

30cm	1011
40cm	1012
50cm	1013



1011  
Puxador  
Barra Chata

30cm	17143
40cm	17144
50cm	17145
60cm	17146
70cm	17147
80cm	19164
90cm	17148
100cm	19165
110cm	17142



1011  
Puxador  
Barra Tubular

30cm	17158
40cm	17159
50cm	17160
60cm	17161
70cm	17162
80cm	19161
90cm	17163
100cm	19162
110cm	17157



## RÉGUA GABARITO DE ROSCAS



3000  
Régua Salva Registro

CÓDIGO  
21151

## REPARO SALVA REGISTRO INDIVIDUAL



REPARO SALVA REGISTRO Nº 18	21139
REPARO SALVA REGISTRO Nº 19	21140
REPARO SALVA REGISTRO Nº 20	21141
REPARO SALVA REGISTRO Nº 21	21143
REPARO SALVA REGISTRO Nº 22	21144
REPARO SALVA REGISTRO Nº 23	21145
REPARO SALVA REGISTRO Nº 24	21146
REPARO SALVA REGISTRO Nº 25	21147



628  
Reparo Salva  
Registro  
CÓDIGO  
628



3000  
Reparo Salva Registro  
10 em 1  
CÓDIGO  
24220

**SALVA  
REGISTRO  
10 em 1**

**Conteúdo**  
3 - Módulos de roscas  
3 - Prolongadores de Pistão  
1 - Tucho para Mecanismo MVS  
3 - Anéis de Vedação  
1 - Cabeçote Vedante

KIT FÁCIL DE REPAROS P/ REGISTRO

# MECANISMO DE VEDAÇÃO



3000  
Reparo p/ Registro e Misturador 1/4 de Volta Direito e Esquerdo

DIREITA	228
ESQUERDA	13949



3000  
Reparo p/ Registro MVS Sede Rasa AM. ou CR.

AMARELO	1503
CROMADA	722



3000  
Reparo p/ Registro MVS Sede Funda AM. ou CR.

AMARELO	721
CROMADA	1092



3000  
Reparo p/ Registro ABNT Vedante (metal) AM. ou CR.

AMARELO	13378
CROMADA	13379



3000  
Reparo p/ Registro Vedante Soft AM. ou CR.

AMARELO	723
CROMADA	724



3000  
Reparo p/ Torneira MVS Sede Funda Amarelo ou Cromado

AMARELO	826
CROMADA	1085



3000  
Reparo 1/4 de Volta M18 Classic e Stillus Prática AM. ou CR.

AMARELO	1451
CROMADA	1452



3000  
Reparo 1/4 de Volta M22 Direito e Esquerdo AM. ou CR.

ESTRIA FINA AMARELO	26206
ESTRIA FINA CROMADO	8306
ESTRIA GROSSA AMARELO	1771
ESTRIA GROSSA CROMADO	1772



3000  
Reparo p/ Torneira MVS Sede Rasa AM. ou CR.

AMARELO	1084
CROMADA	720



3000  
Reparo p/ Torneira Vedante Amarelo

C50	987
C52	26728



3000  
Reparo para Registro 1509 3/4" Castelo / Pistão / Cunha

CÓDIGO	27277
--------	-------



3000  
Reparo p/ Torneira Vedante c/ Capacete Cromado

CROMADO	717
---------	-----



3000  
Reparo p/ Torneira ou Registro 1400 Vedante c/ Chaveta AM. ou CR.

AMARELO	715
CROMADA	716



3000  
Reparo p/ Torneira Vedante c/ Cruzeta

C23	1002
C33	1268



3000  
Reparo Automatique

CÓDIGO	549
--------	-----

# DIVERSOS



3000  
Kit alongador para  
pistão Deca x Deca

**CÓDIGO**  
26834

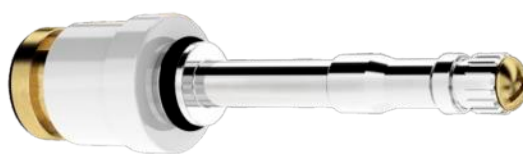

3000  
Reparo p/ Registro MVS Compatível Deca Cromado  
1/2"x3/4" s/ castelo

**CÓDIGO**  
27250

1149  
Adaptador cromado  
para filtro de bancada  
1/2" com regulador  
de vazão e bico  
universal.



**CÓDIGO**  
27345

1149  
Adaptador cromado para  
filtro de parede 1/2"x1/2"  
com regulador de vazão e  
bico universal.



**CÓDIGO**  
27467

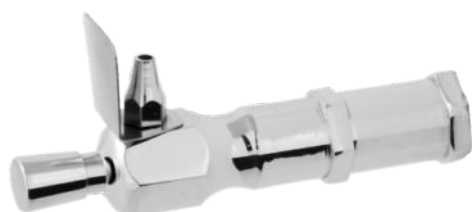

1146  
Jato Reto p/ Bebedouro

**CÓDIGO**  
5957



1149  
Buchas "T" - 1/2" ou 3/4"

**1/2" x 1/2"**   **1/2" x 3/4"**

586

587

3000  
Conversor para Registro  
de Pressão e Gaveta  
DOCOL X DECA



**CÓDIGO**  
28957

3000  
Reparo para Bóia  
Vazão Total 3/4"



**CÓDIGO**  
12050

3000  
Reparo para Bóia  
Vazão Total 1. 1/2"



**CÓDIGO**  
12049

# DIVERSOS



7240  
Tampão Plug ABS

**CÓDIGO**  
6711



1188  
Cesto Metal da Válvula Americana

**CÓDIGO**  
972



1188  
Cesto ABS da Válvula Americana

**CÓDIGO**  
738



6970  
Alongador

1/2" - 4CM	697
1/2" - 6CM	698
1/2" - 8CM	699
3/4" - 4CM	700
3/4" - 6CM	701
3/4" - 8CM	702



7320  
Bico e Porca de metal ou ABS

	METAL	ABS CROM.	ABS BRONZE
1/2"	-	733	732
3/4"	10398	735	734



7290  
Arejador Articulado  
ABS ou Metal p/ Cano 3/4" ou 5/8"

ABS CROM. ROSCA EXTERNA	731
ABS CROM. ROSCA INTERNA	16463
ABS CROM. 3/4" ARTICULADO	393
METAL CROM. 3/4" ARTICULADO	729
METAL CROM. ROSCA INTERNA 3/4"	145
STILLUS PRÁTICA CREE METAL	16465



7250  
Canopla p/ Torneira

**CÓDIGO**  
725



7375  
Fixador de Canopla Longo

**CÓDIGO**  
550



0000  
Sifão Universal Extensível

**CÓDIGO**  
000

# DIVERSOS



7360  
Redução Metal ou Plástico  
de 1/2" para 3/4"

METAL	PLÁSTICO
737	736



7360  
Buchas de Reversão  
3/4" para 1/2"

METAL
235



7370  
Prolongador de Rosca  
1/2" Curto / Médio / Longo

CURTO	MÉDIO	LONGO
245	244	246



1022  
Junção Cromada Parede ou  
Mesa

PAREDE	MESA
1022	15124



1790  
Parafuso de Fixação Latonado ou  
Latão - Buchas 8 / 10/ 12  
Opção: Longo (Bucha 10c/ 11cm)

	LATÃO	LATON.	LONGO
8	676	1790	-
10	677	1791	1879
12	1328	1852	-



1212  
Cano Flexível  
Gourmet 3/4" e Fit

3/4"	5/8" FIT
16803	22889

1150  
Torneira Boia vazão Total  
c/ balão Plástico  
1/2" / 3/4" / 1" / 1.1/2"

	PLÁSTICO
1/2"	424
3/4"	626
1"	627
1.1/2"	956

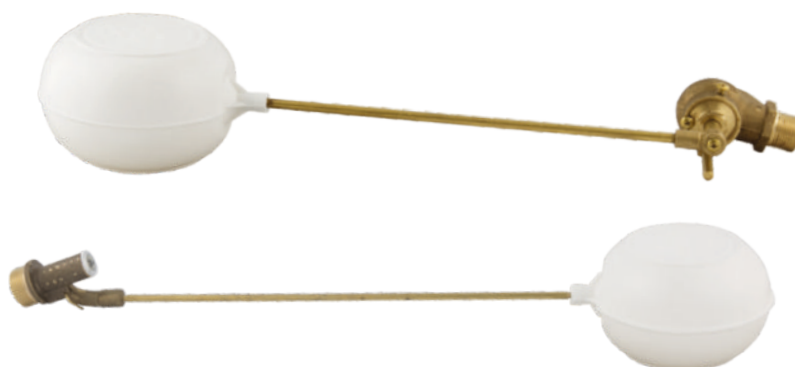

1116  
Torneira Bóia Registro  
c/ balão Plástico ou Metal  
1/2" / 3/4"

	METAL	PLÁSTICO
1/2"	994	624
3/4"	1116	625

## Expositor **Balcão**

969  
Quantidade de torneiras:  
4 torneiras de parede  
4 torneiras de bancada

Altura: 60cm  
Largura: 45cm  
Profundidade: 25cm



## Expositor **Aramado**

Quantidade de torneiras:  
0 torneiras de parede  
0 torneiras de bancada

968  
Expositor Aramado Especial  
Altura: 200cm  
Largura: 98cm  
Profundidade: 50cm

28126  
Expositor Aramado  
Altura: 170cm  
Largura: 74cm  
Profundidade: 50cm



## Expositor Safira/Duplo

971

Safira: Expositor de parede.

Quantidade de torneiras:

6 torneiras de parede

4 torneiras de bancada

555

Safira Duplo: Expositor p/  
Meio de Loja (corredor)

Quantidade de torneiras:

12 torneiras de parede

8 torneiras de bancada



## Expositor Prata

27148

Expositor p/ Meio de Loja (corredor)

com Dupla Face, Montado com Sistema de  
Encaixes.

Altura: 150cm

Largura: 84cm

Profundidade: 45cm



## Expositor Ouro

13107  
Expositor p/ Meio de Loja  
com Canaletado p/ Gancheiras.

Quantidade de torneiras:  
14 torneiras de parede  
8 torneiras de bancada

Altura: 150cm  
Largura: 90cm  
Profundidade: 45cm



## Expositor Diamante

13897  
Expositor p/ Meio de Loja (corredor)  
com Portas e Prateleiras para Armazenar  
Estoque.

Espaço para Exposição de Acessórios  
(Kit Banheiro) 4 Prateleiras Laterais (2 de cada lado)  
para Exposição de Filtros e outros Produtos.

Quantidade de torneiras:  
11 torneiras de parede  
8 torneiras de bancada

Altura: 145cm  
Largura: 190cm  
Profundidade: 60cm



## Expositor **Rubi**

23543

Expositor de Parede,  
com 2 Bancadas para Torneiras  
de Mesa

Quantidade de torneiras:

6 torneiras de parede

5 torneiras de bancada

Altura: 200cm

Largura: 95cm

Profundidade: 60cm



## Expositor **Rubi Canaletado**

23895

Expositor Canaletado

Altura: 200cm

Largura: 95cm

Profundidade: 60cm



## Expositor Rubi Duplo

23544

Expositor de Parede,  
com LED para Destacas as Torneiras  
e Logomarca, com 2 Bancadas para  
Torneiras de Mesa, 1 Pannel Canaletado  
com 30 Ganchos.

Quantidade de torneiras:

6 torneiras de parede  
5 torneiras de bancada

Altura: 200cm

Largura: 95+95cm

Profundidade: 60cm



## Expositor Rubi Triplo

23545

Expositor de Parede,  
com LED para Destacas as Torneiras  
e Logomarca, com 2 Bancadas para  
Torneiras de Mesa, 2 Pannel Canaletado  
com 30+30 Ganchos.

Quantidade de torneiras:

6 torneiras de parede  
5 torneiras de bancada

Altura: 200cm

Largura: 95+95+95cm

Profundidade: 60cm





**AGUIA**

METAIS





AguiaMetais



AguiaMetais



(44) 99724-0359



(44) 3464-4000

[aguia metais@aguia metais.com.br](mailto:aguia metais@aguia metais.com.br)

[www.aguia metais.com.br](http://www.aguia metais.com.br)



Rua Ceará, 390 - CEP 87955-000  
São Pedro do Paraná - PR

